

Agilent 6000 Series Oscilloscope

User's Guide



Agilent Technologies

Notices

© Agilent Technologies, Inc. 2005-2006

No part of this manual may be reproduced in any form or by any means (including electronic storage and retrieval or translation into a foreign language) without prior agreement and written consent from Agilent Technologies, Inc. as governed by United States and international copyright laws.

Manual Part Number

54684-97011

Edition

Fourth Edition, June 2006

Printed in Malaysia

Agilent Technologies, Inc.
395 Page Mill Road
Palo Alto, CA 94303 USA

A newer version of this manual may be available at

www.agilent.com/find/mso6000

Software Revision

This guide was written for version 03.50 of the Agilent 6000 Series Oscilloscope software.

Warranty

The material contained in this document is provided “as is,” and is subject to being changed, without notice, in future editions. Further, to the maximum extent permitted by applicable law, Agilent disclaims all warranties, either express or implied, with regard to this manual and any information contained herein, including but not limited to the implied warranties of merchantability and fitness for a particular purpose. Agilent shall not be liable for errors or for incidental or consequential damages in connection with the furnishing, use, or performance of this document or of any information contained herein. Should Agilent and the user have a separate written agreement with warranty terms covering the material in this document that conflict with these terms, the warranty terms in the separate agreement shall control.

Technology Licenses

The hardware and/or software described in this document are furnished under a license and may be used or copied only in accordance with the terms of such license.

Restricted Rights Legend

If software is for use in the performance of a U.S. Government prime contract or subcontract, Software is delivered and licensed as “Commercial computer software” as defined in DFAR 252.227-7014 (June 1995), or as a “commercial item” as defined in FAR 2.101(a) or as “Restricted computer software” as defined in FAR 52.227-19 (June 1987) or any equivalent agency regulation or contract clause. Use, duplication or disclosure of Software is subject to Agilent Technologies’ standard commercial license terms, and non-DOD Departments and Agencies of the U.S. Government will

receive no greater than Restricted Rights as defined in FAR 52.227-19(c)(1-2) (June 1987). U.S. Government users will receive no greater than Limited Rights as defined in FAR 52.227-14 (June 1987) or DFAR 252.227-7015 (b)(2) (November 1995), as applicable in any technical data.

Safety Notices

CAUTION

A **CAUTION** notice denotes a hazard. It calls attention to an operating procedure, practice, or the like that, if not correctly performed or adhered to, could result in damage to the product or loss of important data. Do not proceed beyond a **CAUTION** notice until the indicated conditions are fully understood and met.

WARNING

A **WARNING** notice denotes a hazard. It calls attention to an operating procedure, practice, or the like that, if not correctly performed or adhered to, could result in personal injury or death. Do not proceed beyond a **WARNING** notice until the indicated conditions are fully understood and met.

In This User's Guide...

This guide shows you how to use the 6000 Series oscilloscopes. It contains the following chapters and topics:

- 1 Getting Started**
Unpacking and setting up your oscilloscope, using Quick Help.
- 2 Front-Panel Controls**
A quick overview of the front-panel controls.
- 3 Viewing and Measuring Digital Signals**
How to connect and use the digital channels of a mixed-signal oscilloscope (MSO).
- 4 Triggering the Oscilloscope**
Trigger modes, coupling, noise rejection, holdoff, external trigger and more. Edge, pulse width, and pattern triggering. CAN, duration, I²C, Nth Edge Burst, LIN, sequence, SPI, TV/video, and USB triggering modes.
- 5 Making Measurements**
XY mode, FFTs, math functions, using cursors, automatic measurements.
- 6 Displaying Data**
Using pan and zoom; normal, average, peak detect, and high resolution (smoothing) modes; noise rejection modes, glitch capture, and more.
- 7 Saving and Printing Data**
Printing waveforms, saving setups and data, and using the file explorer.
- 8 Reference**
Upgrading a DSO to an MSO, adding memory, software updates, I/O, synchronizing instruments with the 10 MHz reference clock, warranty status, digital signal probing, and more.
- 9 Characteristics and Specifications**
This chapter give the specifications and characteristics of the oscilloscope.

The Agilent 6000 Series color oscilloscopes deliver powerful features and high performance:

- 100 MHz, 300 MHz, 500 MHz, and 1 GHz bandwidth models.
- Up to 4 GSa/s sample rate.
- Powerful triggering including analog HDTV, I²C, SPI, LIN, CAN, and USB.
- USB, LAN, and GPIB ports make printing, saving and sharing data easy.
- 2-channel and 4-channel Digital Storage Oscilloscope (DSO) models.
- 2+16-channel and 4+16-channel Mixed Signal Oscilloscope (MSO) models.
- An MSO lets you debug your mixed-signal designs using up to four analog signals *and* 16 tightly correlated digital signals simultaneously.

The 6000 Series oscilloscopes feature MegaZoom III technology:

- Most responsive deep memory.
- Highest definition color display.
- Fastest waveform update rates, uncompromised.

- You can easily upgrade from a DSO to an MSO or increase memory depth.

For more information about 6000 Series oscilloscopes, see www.agilent.com/find/mso6000.

Table 1 6000 Series Oscilloscopes Model Numbers and Sampling Rates

Bandwidth	100 MHz	300 MHz	500 MHz	1 GHz
Maximum Sample Rate	2 GSa/s	2 GSa/s	4 GSa/s	4 GSa/s
2-Channel + 16 Logic Channels MSO	MSO6012A	MSO6032A	MSO6052A	MSO6102A
4-Channel + 16 Logic Channels MSO	MSO6014A	MSO6034A	MSO6054A	MSO6104A
2-Channel DSO	DSO6012A	DSO6032A	DSO6052A	DSO6102A
4-Channel DSO	DSO6014A	DSO6034A	DSO6054A	DSO6104A

Table 2 6000 Series Oscilloscopes Memory Depth Option Numbers

Maximum Memory Depth	1 Mpts	2 Mpts	8 Mpts
MSO/DSO6012, MSO/DSO6014, MSO/DSO6032, MSO/DSO6034 oscilloscopes	standard	2ML	8ML
MSO/DSO6052, MSO/DSO6054 oscilloscopes	standard	2MH	8MH
MSO/DSO6102, MSO/DSO6104 oscilloscopes	standard	2MH	8MH

Digital Channels

Because all of the oscilloscopes in the Agilent 6000 Series have analog channels, the analog channel topics in this book apply to all instruments. Whenever a topic discusses the digital channels, that information applies only to Mixed-Signal Oscilloscope (MSO) models or DSO models that have been upgraded to an MSO.

Contents

1	Getting Started	15
	To inspect package contents	16
	To adjust the handle	19
	To power-on the oscilloscope	20
	Ventilation requirements	20
	To connect the oscilloscope probes	22
	To verify basic oscilloscope operation	23
	To compensate the oscilloscope probes	24
	To calibrate the probes	25
	Passive Probes Supported	25
	Active Probes Supported	26
	By 300 MHz, 500 MHz, and 1 GHz Bandwidth Models	26
	By 100 MHz Bandwidth Models	27
	Using Quick Help	28
	Quick Help Languages	29
2	Front-Panel Controls	31
	Front-Panel Overview	32
	Conventions	33
	Graphic Symbols in Softkey Menus	33
	4-Channel 6000 Series Oscilloscope Front Panel	34
	Front Panel Controls	35
	2-Channel 6000 Series Oscilloscope Front Panel (differences only)	39
	Interpreting the display	39

Front-Panel Operation	41
To adjust the waveform intensity	41
To adjust the display grid (graticule) intensity	41
To start and stop an acquisition	42
To make a single acquisition	43
To pan and zoom	44
Choosing Auto trigger mode or Normal trigger mode	45
Using Autoscale	45
To set the probe attenuation factor	46
Using the analog channels	48
To set up the Horizontal time base	53
To make cursor measurements	60
To make automatic measurements	61
Using Labels	61
To print the display	66
To set the clock	66
To set up the screen saver	67
To set the waveform expansion reference point	68
To perform service functions	69
User Calibration	69
Self Test	72
About Oscilloscope	72
To restore the oscilloscope to its default configuration	73
3 Viewing and Measuring Digital Signals	75
To connect the digital probes to the circuit under test	76
Acquiring waveforms using the digital channels	79
To display digital channels using Autoscale	80
Example	80
Interpreting the digital waveform display	82
To switch all digital channels on or off	83

	To switch groups of channels on or off	83
	To switch a single channel on or off	83
	To change the displayed size of the digital channels	84
	To reposition a digital channel	84
	To change the logic threshold for digital channels	85
4	Triggering the Oscilloscope	87
	Selecting Trigger Modes and Conditions	90
	To select the Mode and Coupling menu	90
	Trigger modes: Normal and Auto	91
	To select trigger Coupling	93
	To select trigger Noise Rejection and HF rejection	93
	To set Holdoff	94
	The External Trigger input	96
	2-Channel oscilloscope External Trigger input	96
	4-Channel oscilloscope External Trigger input	98
	Trigger Types	99
	To use Edge triggering	100
	Trigger level adjustment	101
	To use Pulse Width triggering	102
	< qualifier time set softkey	104
	> qualifier time set softkey	104
	To use Pattern triggering	105
	To use CAN triggering	107
	To use Duration triggering	111
	< qualifier time set softkey	113
	> qualifier time set softkey	113
	To use I2C triggering	114

Contents

To use Nth Edge Burst triggering	120
To use LIN triggering	122
To use Sequence triggering	125
Define the Find: stage	127
Define the Trigger on: stage	128
Define the optional Reset on: stage	130
Adjust the trigger level	131
To use SPI triggering	132
Assign source channels to the clock, data, and frame signals	134
Set up the number of bits in the serial data string and set values for those data bits	137
Resetting all bits in the serial data string to one value	137
To use TV triggering	137
Example exercises	141
To trigger on a specific line of video	141
To trigger on all sync pulses	143
To trigger on a specific field of the video signal	144
To trigger on all fields of the video signal	145
To trigger on odd or even fields	146
To use USB triggering	149
The Trigger Out connector	151
Triggers	151
Source frequency	151
Source frequency/8	151
5 Making Measurements	153
To use the XY horizontal mode	154

Math Functions	159
Math scale and offset	160
Multiply	161
Subtract	163
Differentiate	165
Integrate	167
FFT Measurement	169
FFT Operation	171
Cursor Measurements	176
To make cursor measurements	176
Cursor Examples	179
Automatic Measurements	182
To make an automatic measurement	183
To set measurement thresholds	184
Time Measurements	186
Delay and Phase Measurements	191
Voltage Measurements	193
Overshoot and Preshoot Measurements	199
6 Displaying Data	201
Pan and Zoom	202
To pan and zoom a waveform	202
To set the waveform expansion reference point	203
Antialiasing	204
Using the XGA video output	204
Display Settings	205
Infinite persistence	205
Grid intensity	206
Vectors (connect the dots)	206
Varying the intensity to view signal detail	207

Acquisition Modes	209
At Slower Sweep Speeds	209
Normal Mode	209
Peak Detect Mode	210
High Resolution Mode	210
Averaging Mode	211
Realtime Sampling Option	213
Using Serial Decode	215
To decode I ² C data	216
To decode SPI data	220
To decode CAN data	225
CAN Totalizer	230
To decode LIN data	232
To reduce the random noise on a signal	238
HF Reject	238
LF Reject	239
Noise rejection	239
To capture glitches or narrow pulses with peak detect and infinite persistence	240
Using peak detect mode to find a glitch	241
How Autoscale Works	243
Undo Autoscale	243
Specifying the Channels Displayed After Autoscale	244
7 Saving and Printing Data	245
To configure printing	246
Selecting a print file format	246
Selecting print options	249
Print Palette	249
To print the display to a file	250
To print the display to a USB printer	251

Supported printers	252
Printers currently available in stores	252
Legacy Printers	253
Secure Environment Mode Option	254
Saving and recalling traces and setups	255
To Autosave traces and setups	256
To save traces and setups to internal memory or to overwrite an existing USB mass storage device file	257
To save traces and setups to a new file on the USB mass storage device	258
To recall traces and setups	260
To use the file explorer	261
8 Reference	263
Upgrading to an MSO or adding memory depth	264
Software and firmware updates	264
To set up the I/O port	265
To use the web interface	265
Using the 10 MHz reference clock	267
Sample clock and frequency counter accuracy	267
Supplying an external timebase reference	267
To supply a sample clock to the oscilloscope	267
To synchronize the timebase of two or more instruments	269
To check warranty and extended services status	269
To return the instrument	270
To clean the oscilloscope	270

Contents

Digital channel signal fidelity: Probe impedance and grounding	271
Input Impedance	271
Probe Grounding	273
Best Probing Practices	275
To replace digital probe leads	276
Binary Data (.bin)	277
Binary Data in MATLAB	277
Binary Header Format	277
Example Program for Reading Binary Data	281
Examples of Binary Files	282

9 Characteristics and Specifications 285

Specifications	286
Characteristics	287
Environmental Conditions	297
Overvoltage Category	297
Pollution Degree	297
Pollution Degree Definitions	297
Measurement Category	298
Measurement Category	298
Measurement Category Definitions	298
Transient Withstand Capability	299

Index 301



1 Getting Started

To inspect package contents	16
To adjust the handle	19
To power-on the oscilloscope	20
Ventilation requirements	20
To connect the oscilloscope probes	22
To verify basic oscilloscope operation	23
To compensate the oscilloscope probes	24
To calibrate the probes	25
Passive Probes Supported	25
Active Probes Supported	26
Using Quick Help	28

To get started using the oscilloscope:

- ✓ Unpack the oscilloscope and verify the contents.
- ✓ Adjust the oscilloscope's handle position.
- ✓ Apply power to the oscilloscope.
- ✓ Connect the probes to the oscilloscope.
- ✓ Verify basic oscilloscope operation and compensate the probes.

A Quick Help system is built into the oscilloscope. Instructions for using the quick help system are given on [page 28](#).



Digital Channels

Because all of the oscilloscopes in the Agilent 6000 Series have analog channels, the analog channel topics in this book apply to all instruments. Whenever a topic discusses the digital channels, that information applies only to Mixed-Signal Oscilloscope (MSO) models or DSO models that have been upgraded to an MSO.

To inspect package contents

- ✓ Inspect the shipping container for damage.

If your shipping container appears to be damaged, keep the shipping container or cushioning material until you have inspected the contents of the shipment for completeness and have checked the oscilloscope mechanically and electrically.

- ✓ Verify that you received the following items and any optional accessories you may have ordered:
 - 6000 Series Oscilloscope
 - Front-panel cover
 - Power cord (see [Table 4](#) on page 21)
 - Oscilloscope probes
 - Two probes for 2-channel models
 - Four probes for 4-channel models
 - 10074C probes for 100 MHz bandwidth models
 - 10073C probes for all other models
 - Manuals
 - User's Guide
 - Service Guide
 - Programmer's Quick Start Guide
 - CD-ROM containing the Programmer's Reference Guide
 - Automation-Ready Software CD-ROM
 - MSO Models: digital probe kit (54620-68701) and digital cable guide (54684-42301)

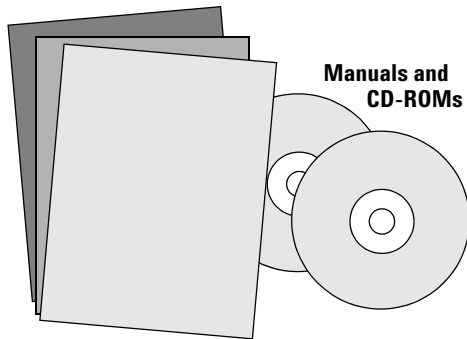
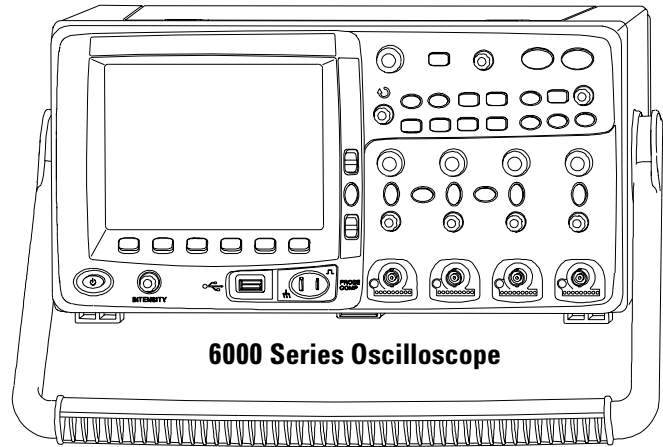
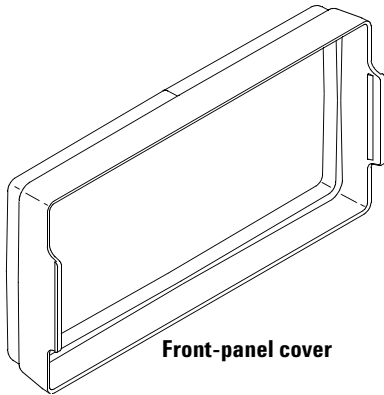

Oscilloscope probes
10073C or 10074C
(qty 2 or 4)

Power cord
(Part numbers given
on [page 21](#))

*Digital Probe Kit contains:
54620-61801 16-channel cable (qty 1)
5959-9334 2-inch probe ground leads (qty 5)
5090-4833 Grabber (qty 20)
Digital probe replacement parts are listed on [page 276](#)

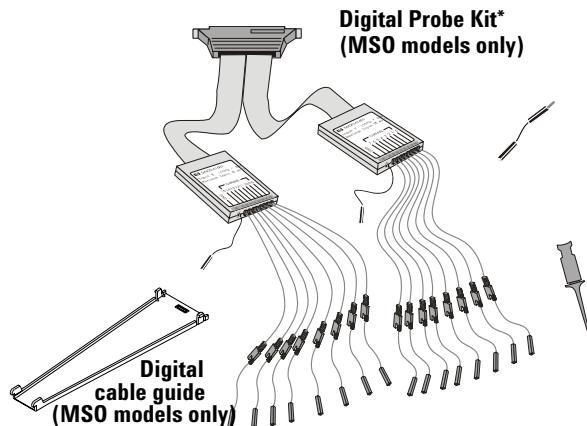

Package contents for 6000 Series Oscilloscopes

Table 3 Accessories available

Model	Description
N2918A	6000 Series Oscilloscope Evaluation Kit
1180CZ	Testmobile oscilloscope cart (requires N2919A adapter kit)
N2919A	Testmobile Adapter Kit
54684-44101	Front-panel cover
N2605A-097	USB cable
10833A	GPIB cable, 1 m long
10073C	Passive probe, 10:1, 500 MHz, 1.5 m
10074C	Passive probe, 10:1, 100 MHz, 1.5 m
54620-68701	Digital probe kit
54684-42301	Digital probe cable guide (cable tray)
Pomona 4119-50	50-Ohm Feedthrough (not available from Agilent Technologies)
1130A	InfiniiMax 1.5 GHz InfiniiMax differential probe amplifier
1141A	InfiniiMax 200 MHz differential probe (with 1142A power supply)
1144A	800 MHz active probe (with 1142A power supply)
1145A	750 MHz 2-channel active probe (with 1142A power supply)
1156A	1.5 GHz active probe
01650-61607	16:16 logic cable and terminator (for use with header on target system)
54620-68701	16:2 x 8 logic input probe assembly (shipped standard with MSO models)
1146A	100 kHz Current probe, AC/DC
10070C	1:1 Passive Probe
10072A	Fine-pitch probe kit
10075A	0.5 mm IC clip kit
10076A	100:1, 4 kV 250 MHz probe
E2613B	0.5 mm Wedge probe adapter, 3-signal, qty 2
E2614A	0.5 mm Wedge probe adapter, 8-signal, qty 1
E2615B	0.65 mm Wedge probe adapter, 3-signal, qty 2
E2616A	0.65 mm Wedge probe adapter, 8-signal, qty 1
E2643A	0.5 mm Wedge probe adapter, 16-signal, qty 1
E2644A	0.65 mm Wedge probe adapter, 16-signal, qty 1
N2772A	20 MHz differential probe
N2773A	Power supply for N2772A
N2774A	50 MHz current probe AC/DC
N2775A	Power supply for N2774A

To adjust the handle

You can use the oscilloscope's handle for carrying the instrument, or you can use it as a stand to tilt the instrument up for easier viewing of its display.

- 1 Grasp the handle hubs on each side of the instrument and pull the hubs out until they stop.

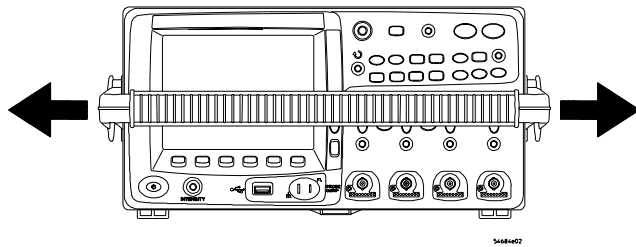

- 2 Without releasing the hubs, rotate the handle to the desired position. Then release the hubs. Continue rotating the handle until it clicks into a set position.

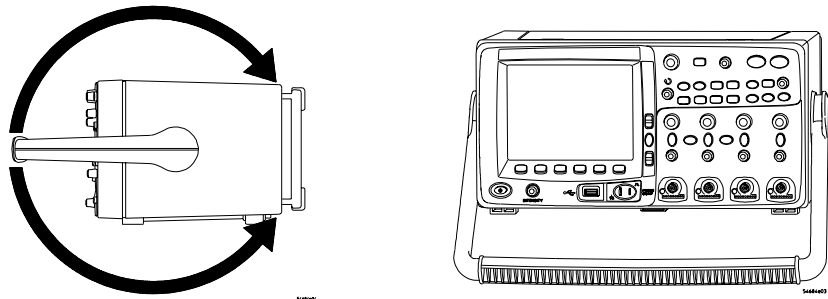

To power-on the oscilloscope

- 1 Connect the power cord to the rear of the oscilloscope, then to a suitable AC voltage source.

The oscilloscope power supply automatically adjusts for input line voltages in the range 100 to 240 VAC. Ensure that you have the correct line cord. See [Table 4](#) on page 21. The line cord provided is matched to the country of origin.

WARNING

Always use a grounded power cord. Do not defeat the power cord ground.

- 2 Press the power switch.

The power switch is located on the lower left corner of the front panel. Some front panel key lights will come on and the oscilloscope will be operational in a few seconds.













Ventilation requirements

The air intake and exhaust areas must be free from obstructions. Unrestricted air flow is required for proper cooling.

The fan draws air in from underneath the oscilloscope and pushes it out behind the oscilloscope. Always ensure that the air intake and exhaust areas are free from obstructions.

When using the oscilloscope in a bench-top setting, provide at least 4" (100 mm) clearance behind and above the oscilloscope for proper cooling.

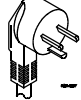
Table 4 Power Cords

Plug Type	Cable Part Number	Plug Type	Cable Part Number
Opt 900 (U.K.) 	8120-1703	Opt 918 (Japan) 	8120-4754
Opt 901 (Australia) 	8120-0696	Opt 919 (Israel) 	8120-6799
Opt 902 (Europe) 	8120-1692	Opt 920 (Argentina) 	8120-6871
Opt 903 (U.S.A.) 	8120-1521	Opt 921 (Chile) 	8120-6979
Opt 906 (Switzerland) 	8120-2296	Opt 922 (China) 	8120-8377
Opt 912 (Denmark) 	8120-2957	Opt 927 (Thailand) 	8120-8871
Opt 917 (Africa) 	8120-4600		

To connect the oscilloscope probes

The analog input impedance of the 100 MHz oscilloscopes is fixed at 1 M Ω . The 1 M Ω mode is for use with many passive probes and for general purpose measurements. The high impedance minimizes the loading effect of the oscilloscope on the circuit under test. If a 50 Ω input impedance is required, attach a 50 Ω feedthrough termination such as Pomona 4119-50 (not available from Agilent Technologies) to the oscilloscope's channel input BNC connector.

The analog input impedance of the 300 MHz, 500 MHz, and 1 GHz oscilloscopes can be set to either 50 Ω or 1 M Ω . The 50 Ω mode matches 50 Ω cables and some active probes commonly used in making high frequency measurements. This impedance matching gives you the most accurate measurements since reflections are minimized along the signal path.

- 1 Connect the supplied oscilloscope probe to an oscilloscope channel BNC connector on the front panel of the oscilloscope.
- 2 Connect the retractable hook tip on the probe tip to the circuit point of interest. Be sure to connect the probe ground lead to a ground point on the circuit.

CAUTION



Do not exceed 5 Vrms at the BNC in 50 Ω mode on the Agilent 6000 Series oscilloscopes. Input protection is enabled in 50 Ω mode and the 50 Ω load will disconnect if greater than 5 Vrms is detected. However the inputs could still be damaged, depending on the time constant of the signal. The 50 Ω input protection mode on the Agilent 6000 Series oscilloscopes only functions when the oscilloscope is powered on.

CAUTION

The probe ground lead is connected to the oscilloscope chassis and the ground wire in the power cord. If you need to measure between two live points, use a differential probe. Do not negate the protective action of the three-conductor power cable by disconnecting the oscilloscope from ground. The oscilloscope must remain grounded through its power cord for safety.

CAUTION

Maximum input voltage for analog inputs:

CAT I 300 Vrms, 400 Vpk; transient overvoltage 1.6 kVpk

CAT II 100 Vrms, 400 Vpk

with 10073C or 10074C 10:1 probe: CAT I 500 Vpk, CAT II 400 Vpk

To verify basic oscilloscope operation

- 1 Press the **Save/Recall** key on the front panel, then press the **Default Setup** softkey. (The softkeys are located directly below the display on the front panel.) The oscilloscope is now configured to its default settings.
- 2 Connect an oscilloscope probe from channel 1 to the **Probe Comp** signal terminal on the front panel.
- 3 Connect the probe's ground lead to the ground terminal that is next to the **Probe Comp** terminal.
- 4 Press **Autoscale**.
- 5 You should see a waveform on the oscilloscope's display similar to this:

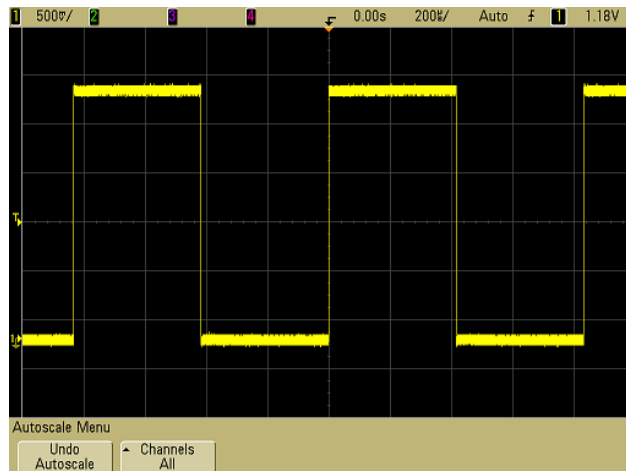

If you see the waveform, but the square wave is not shaped correctly as shown above, perform the procedure “[To compensate the oscilloscope probes](#)” on page 24.

If you do not see the waveform, ensure your power source is adequate, the oscilloscope is properly powered-on, and the probe is connected securely to the front-panel oscilloscope channel input BNC and to the Probe Comp terminal.

To compensate the oscilloscope probes

You should compensate your oscilloscope probes to match their characteristics to the oscilloscope’s channels. A poorly compensated probe can introduce measurement errors.

- 1 Perform the procedure “[To verify basic oscilloscope operation](#)” on page 23.
- 2 Use a nonmetallic tool to adjust the trimmer capacitor on the probe for the flattest pulse possible. The trimmer capacitor is located on the probe BNC connector.

Perfectly compensated

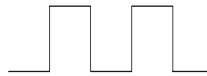

Over compensated



Under compensated



- 3 Connect probes to all other oscilloscope channels (channel 2 of a 2-channel oscilloscope, or channels 2, 3, and 4 of a 4-channel oscilloscope). Repeat the procedure for each channel. This matches each probe to each channel.

The process of compensating the probes serves as a basic test to verify that the oscilloscope is functional.

To calibrate the probes

The oscilloscope can accurately calibrate its analog oscilloscope channels to certain active probes, such as InfiniiMax probes. Other probes, such as the 10073C and 10074C passive probes, do not require calibration. The Calibrate Probe softkey will be grayed-out (displayed in faint text) when a connected probe does not require calibration.

When you connect a probe that can be calibrated (such as an InfiniiMax probe), the **Calibrate Probe** softkey in the channel's menu will become active. Connect the probe to the Probe Comp terminal, and the probe ground to the Probe Comp ground terminal. Press the **Calibrate Probe** softkey and follow the instructions on the display.

NOTE

When calibrating a differential probe, connect the positive lead to the Probe Comp terminal and the negative lead to the Probe Comp ground terminal. You may need to connect an alligator clip to the ground lug to allow a differential probe to span between the Probe Comp test point and ground. A good ground connection ensures the most accurate probe calibration.

Passive Probes Supported

The following passive probes can be used with the 6000 Series oscilloscopes. Any combination of passive probes can be used.

Table 5 Passive Probes

Passive Probes	Quantity Supported
10070C	4
10073C	4
10074C	4
10076A	4
All Infiniium passive probes	4

Active Probes Supported

By 300 MHz, 500 MHz, and 1 GHz Bandwidth Models

Active probes that do not have their own external power supply require substantial power from the AutoProbe interface. (The AutoProbe interface is present on the 300 MHz, 500 MHz, and 1 GHz bandwidth models.) “Quantity Supported” indicates the maximum number of each type of active probe that can be connected to the oscilloscope. If too much current is drawn from the AutoProbe interface, an error message will be displayed, indicating that you must momentarily disconnect all probes to reset the AutoProbe interface.

Table 6 Active Probes for 300 MHz, 500 MHz, and 1 GHz bandwidth models

Active Probes	Quantity Supported
1130A	2
1131A	2
1132A	2
1134A	2
1141A	4
1144A	4
1145A	2
1147A	2
1156A	4
1157A	4
1158A	4

By 100 MHz Bandwidth Models

The following active probes use their own power supply. Therefore, they can be used on all 6000 Series oscilloscopes, including the 100 MHz bandwidth models.

Many active probes have a 50 Ω input impedance. The input impedance of 6000 Series 100 MHz bandwidth models is fixed at 1 M Ω . When connecting these probes to 6000 Series 100 MHz bandwidth models, a 50 Ω feedthrough terminator such as Pomona 4119-50 (not available from Agilent Technologies) is required.

Table 7 Active Probes for All 6000 Series Oscilloscopes

Active Probes	Quantity Supported
1141A with 1142A supply	4
1144A with 1142A supply	4
1145A with 1142A supply	2
N2772A with N2773A supply	4
N2774A with N2775A supply	4

Using Quick Help

The oscilloscope has a Quick Help system that provides help for each front-panel key and softkey.

To view Quick Help information:

- 1 **Press** and **hold** down the key or softkey for which you would like to view help.

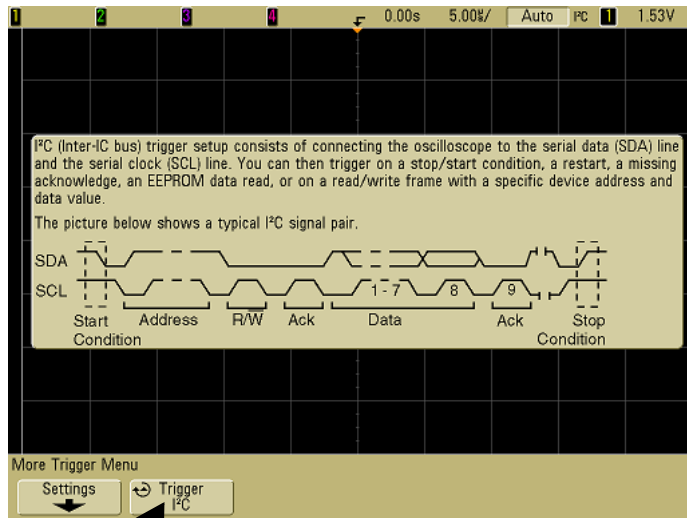

Press and Hold Key

You can set Quick Help to close when you release the key (this is the default mode) or to remain on the screen until another key is pressed or a knob is turned. To select this mode, press the **Utility** key, then press the **Language** softkey, then press the **Help Remain/Help Close** softkey.

Quick Help Languages

At the time this manual was published, Quick Help was available in English, Simplified Chinese, Japanese, German, French, and Russian.

To choose a Quick Help language in the oscilloscope:

- 1 Press **Utility**, then press the **Language** softkey.
- 2 Repeatedly press and release the next **Language** softkey until the desired language is selected.

If Quick Help updates become available, you can download the updated Quick Help language file and load it into the oscilloscope.

To download the 6000 Series Oscilloscope Quick Help Language Support file:

- 1 Point your web browser to www.agilent.com/find/mso6000.
- 2 On the resulting page, select **Technical Support**, then select **Software Downloads & Utilities**.

1 Getting Started



2 Front-Panel Controls

Front-Panel Overview	32
Front-Panel Operation	41



Front-Panel Overview

This chapter provides an introduction to the front-panel controls of the Agilent 6000 Series oscilloscope. Generally, you set up the front-panel controls and then make a measurement.

The keys on the front panel bring up softkey menus on the display that provide access to oscilloscope features. Many softkeys use the Entry knob  to select values.

Six softkeys are located below the display. To understand the symbols used in the softkey menus and throughout this guide, see “Conventions” on page 33.

Note that the Digital Select key, not the Entry knob, is used to select digital channels when you want to reposition a digital channel waveform.

NOTE

The simplest way to set up the oscilloscope is to connect it to the signals of interest and press the **Autoscale** key.

Conventions



Throughout this book, the front-panel keys and softkeys are denoted by a change in font. For example, the **Cursors** key is in the Measure section of the front panel. The **Acq Mode** softkey is the left-most softkey when the Acquire menu is displayed.

In this manual, instructions for pressing a series of keys are written in an abbreviated manner. Pressing the **Utility** key, then the **I/O** softkey, then the **Show I/O Config** softkey is abbreviated as follows:

Press **Utility** → **I/O** → **Show I/O Config**.

Graphic Symbols in Softkey Menus

The following graphic symbols appear in the oscilloscope's softkey menus. The softkey menus appear at the bottom of the display, just above the six softkeys.

 Use the Entry knob to adjust the parameter. The Entry knob is located on the front panel. The  symbol above the knob is illuminated when this control is active.

 Press the softkey to display a pop up with a list of choices. Repeatedly press the softkey until your choice is selected.

 Use the Entry knob labeled  or press the softkey to adjust the parameter.

✓ Option is selected and operational.

■ Feature is on. Press the softkey again to turn the feature off.

□ Feature is off. Press the softkey again to turn the feature on.

▼ Press the softkey to view the menu.

▲ Press the softkey to return to the previous menu.

4-Channel 6000 Series Oscilloscope Front Panel

The following diagram shows the front panel of the 6000 Series 4-channel oscilloscopes. The controls of the 2-channel oscilloscopes are very similar. For a diagram showing the differences of the 2-channel oscilloscope, see [page 39](#).

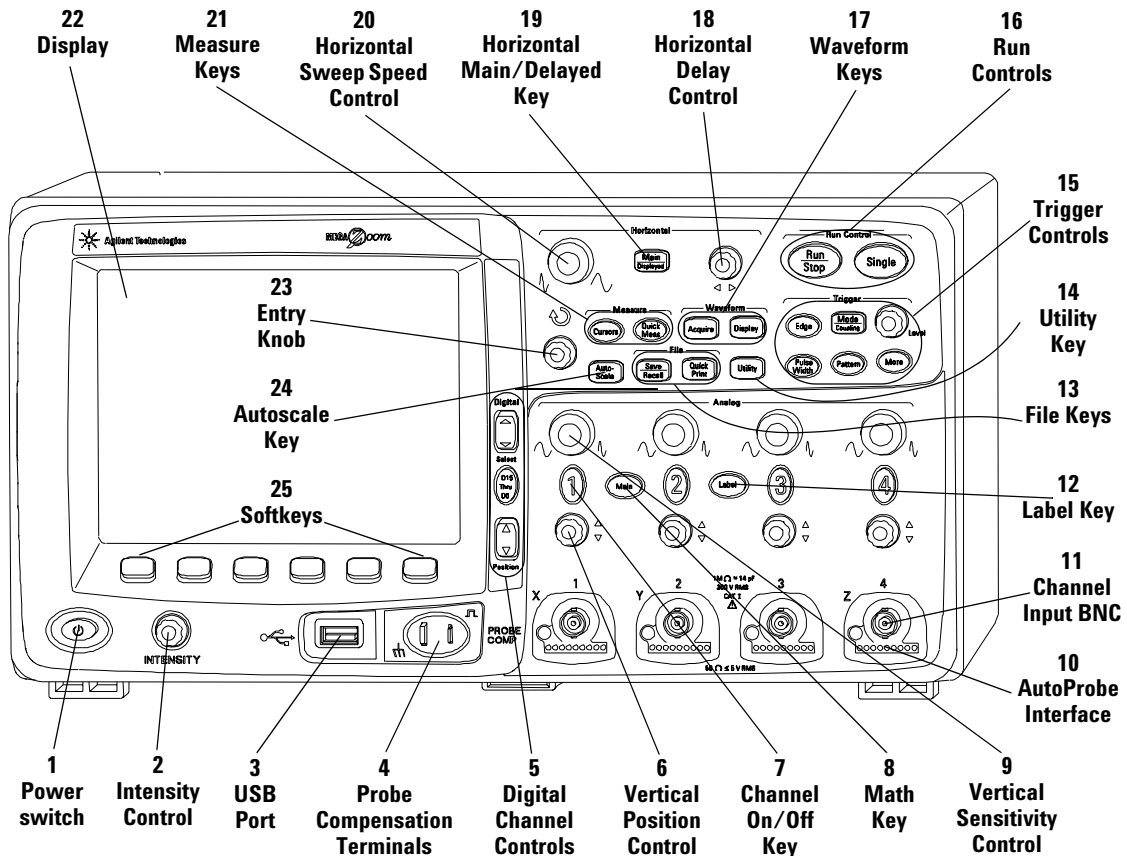

Figure 1 6000 Series 4-Channel Oscilloscope Front Panel

Front Panel Controls

1. Power Switch Press once to switch power on; press again to switch power off. See [page 20](#).

2. Intensity Control Rotate clockwise to increase analog waveform intensity; counterclockwise to decrease. You can vary the intensity control to bring out signal detail, much like an analog oscilloscope. Digital channel waveform intensity is not adjustable. More details about using the Intensity control to view signal detail are on [page 207](#).

3. USB Port Connect a USB compliant mass storage device to store or recall oscilloscope setup files or waveforms. You can also use the USB port to update the oscilloscope's system software or Quick Help language files if updates are available. You do not need to take special precautions before removing the USB mass storage device from the oscilloscope (you do not need to "eject" it). Simply unplug the USB mass storage device from the oscilloscope when the file operation is complete. More information on using the USB port is given in [Chapter 7](#), "Saving and Printing Data," starting on page 245.

4. Probe Compensation Terminals Use the signal at these terminals to match each probe's characteristics to the oscilloscope channel to which it is connected. See [page 24](#).

5. Digital Channel Controls These controls switch the digital channels on/off, and can be used to select a digital channel for repositioning on the display. You can press the D15 Thru D0 key to show the Digital Channel Menu above the softkeys. See [Chapter 3](#), "Viewing and Measuring Digital Signals," starting on page 75.

6. Vertical Position Control Use this knob to change the channel's vertical position on the display. There is one Vertical Position control for each channel. See ["Using the analog channels"](#) on page 48.

7. Channel On/Off Key Use this key to switch the channel on or off, or to access the channel's menu in the softkeys. There is one Channel On/Off key for each channel. See [“Using the analog channels”](#) on page 48.

8. Math Key The Math key provides access to FFT (Fast Fourier Transform), multiply, subtract, differentiate, and integrate functions. See [“Math Functions”](#) on page 159.

9. Vertical Sensitivity Use this knob to change the vertical sensitivity (gain) of the channel. See [“Using the analog channels”](#) on page 48.

10. AutoProbe Interface (Not available on 100 MHz bandwidth models.) When you connect a probe to the oscilloscope, the AutoProbe Interface attempts to determine the type of probe and set its parameters in the Probe menu accordingly. See [page 46](#). Note: Although the 100 MHz models lack the AutoProbe interface, they do have a probe sense ring around the BNC. Therefore, the probe attenuation factor will be automatically set when you connect a compatible probe such as the 10073C or 10074C.

11. Channel Input BNC Connector Attach the oscilloscope probe or BNC cable to the BNC connector. This is the channel's input connector.

12. Label Key Press this key to access the Label menu, which lets you enter labels to identify each trace on the oscilloscope display. See [page 61](#).

13. File Keys Press the File key to access file functions such as save or recall a waveform or setup. Or press the Quick Print key to print the waveform from the display. See [“Saving and recalling traces and setups”](#) on page 255.

14. Utility Key Press this key to access the Utility menu, which lets you configure the oscilloscope's I/O settings, printer configuration, file explorer, service menu, and other options.

15. Trigger Controls These controls determine how the oscilloscope triggers to capture data. See [“Choosing Auto trigger mode or Normal trigger mode”](#) on page 45 and [Chapter 4](#), [“Triggering the Oscilloscope,”](#) starting on page 87.

16. Run Controls Press Run/Stop to make the oscilloscope begin looking for a trigger. The Run/Stop key will illuminate in green. If the trigger mode is set to “Normal,” the display will not update until a trigger is found. If the trigger mode is set to “Auto,” the oscilloscope looks for a trigger, and if none is found, it will automatically trigger, and the display will immediately show the input signals. In this case, the background of the **Auto** indicator at the top of the display will flash, indicating that the oscilloscope is forcing triggers.

Press Run/Stop again to stop acquiring data. The key will illuminate in red. Now you can pan across and zoom-in on the acquired data.

Press Single to make a single acquisition of data. The key will illuminate in yellow until the oscilloscope triggers. See [“To start and stop an acquisition”](#) on page 42.

17. Waveform Keys The Acquire key lets you set the oscilloscope to acquire in Normal, Peak Detect, Averaging, or High Resolution modes (see [“Acquisition Modes”](#) on page 209), and lets you turn Realtime sampling off or on (see [page 213](#)). The Display key lets you access the menu where you can select infinite persistence (see [page 205](#)), switch vectors on or off (see [page 206](#)), and adjust the display grid (graticule) intensity (see [page 206](#)).

18. Horizontal Delay Control When the oscilloscope is running, this control lets you set the acquisition window relative to the trigger point. When the oscilloscope is stopped, you can turn this knob to pan through the data horizontally. This lets you see the captured waveform before the trigger (turn the knob clockwise) or after the trigger (turn the knob counterclockwise). See [“To set up the Horizontal time base”](#) on page 53.

19. Horizontal Main/Delayed Key Press this key to access the menu where you can split the oscilloscope display into Main and Delayed sections, and where you can select XY and Roll modes. You can also select horizontal time/division vernier and select the trigger time reference point on this menu. See [“To set up the Horizontal time base”](#) on page 53.

20. Horizontal Sweep Speed Control Turn this knob to adjust the sweep speed. This changes the time per horizontal division on the display. When adjusted after the waveform has been acquired and the oscilloscope is stopped, this has the effect of stretching out or squeezing the waveform horizontally. See [“To set up the Horizontal time base”](#) on page 53.

21. Measure Keys Press the Cursors key to switch on cursors that you can use for making measurements. Press the **Quick Meas** key to access a set of predefined measurements. See [Chapter 5, “Making Measurements,”](#) starting on page 153.

22. Display The display shows captured waveforms using a different color for each channel. For more information about display modes see [Chapter 6, “Displaying Data,”](#) starting on page 201. Signal detail is displayed using 256 levels of intensity. For more information about viewing signal detail see [“Varying the intensity to view signal detail”](#) on page 207.

23. Entry Knob The entry knob is used to select items from menus and to change values. Its function changes based upon which menu is displayed. Note that the curved arrow symbol  above the entry knob illuminates whenever the entry knob can be used to select a value. Use the entry knob to select among the choices that are shown on the softkeys.

24. Autoscale Key When you press the Autoscale key the oscilloscope will quickly determine which channels have activity, and it will turn these channels on and scale them to display the input signals. See [“How Autoscale Works”](#) on page 243

25. Softkeys The functions of these keys change based upon the menus shown on the display directly above the keys.

2-Channel 6000 Series Oscilloscope Front Panel (differences only)

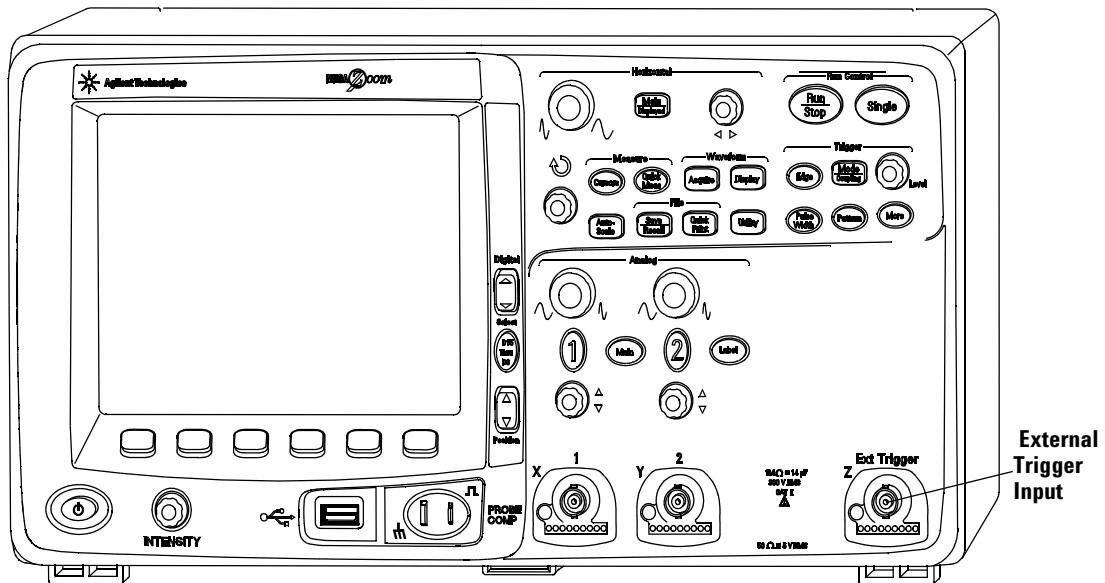

Figure 2 6000 Series 2-Channel Oscilloscope Front Panel

The differences between the front panel of the 4-channel oscilloscopes and the 2-channel oscilloscopes are:

- The 2-channel oscilloscope has two sets of channel controls
- The 2-channel oscilloscope's external trigger input is on the front panel instead of the rear panel. Some trigger features differ. See [“The External Trigger input”](#) on page 96.

Interpreting the display

The oscilloscope display contains channel acquisitions, setup information, measurement results, and softkeys for setting up parameters.



Figure 3 Interpreting the display

Status line The top line of the display contains vertical, horizontal, and trigger setup information.

Display area The display area contains the waveform acquisitions, channel identifiers, and analog trigger and ground level indicators. Each analog channel's information appears in a different color.

Measurement line This line normally contains automatic measurement and cursor results, but can also display advanced trigger setup data and menu information.

Softkeys The softkeys let you set up additional parameters for the selected mode or menu.

Front-Panel Operation

This section provides a brief overview of operating the front-panel controls. Detailed oscilloscope operating instructions are provided in later chapters.

Digital Channels

Because all of the oscilloscopes in the 6000 Series have analog channels, the analog channel topics in this book apply to all instruments. Whenever a topic discusses the digital channels, that information applies only to Mixed-Signal Oscilloscope (MSO) models or DSO models that have been upgraded to an MSO.

To adjust the waveform intensity

The Intensity control is at the lower left corner of the front panel near the power switch.

- To decrease waveform intensity, rotate the **Intensity** control counter-clockwise.
- To increase waveform intensity, rotate the **Intensity** control clockwise.

The intensity control does not affect digital channel intensity. Digital channel intensity is fixed.

To adjust the display grid (graticule) intensity

- 1 Press the **Display** key.
- 2 Turn the Entry knob  to change the intensity of the displayed grid. The intensity level is shown in the **Grid** softkey and is adjustable from 0 to 100%.

Each major vertical division in the grid corresponds to the vertical sensitivity shown in the status line at the top of the display.

Each major horizontal division in the grid corresponds to the sweep speed time shown in the status line at the top of the display.

NOTE

To change the analog waveform intensity, turn the Intensity knob at the lower-left corner of the front panel. The digital waveform intensity is not adjustable.

To start and stop an acquisition

- When you press the **Run/Stop** key, it illuminates in green and the oscilloscope is in continuous running mode.

The oscilloscope examines the input voltage at each probe, and updates the display whenever the trigger conditions are met. Trigger processing and screen update rate are optimized based on the oscilloscope settings. The oscilloscope displays multiple acquisitions of the same signal similar to the way an analog oscilloscope displays waveforms.

- When you press the **Run/Stop** key again, it illuminates in red, and the oscilloscope is stopped.

“Stop” is displayed in the trigger mode position in the status line at the top of the display. You can pan and zoom the stored waveform by turning the horizontal and vertical control knobs.

When the oscilloscope is running and you press the **Run/Stop** key, it will flash until the current acquisition is completed. If the acquisition completes immediately, the **Run/Stop** key will not flash.

At slower sweep speeds, you may not want to wait for the acquisition to finish. Just press **Run/Stop** again. The acquisition will stop immediately and a partial waveform will be displayed.

You can display the results of multiple acquisitions using infinite persistence. See [“Infinite persistence”](#) on page 205.

Memory Depth/Record Length**Run/Stop versus Single**

When the oscilloscope is running, the trigger processing and update rate are optimized over the memory depth.

Single

Single acquisitions always use the maximum memory available—at least twice as much memory as acquisitions captured in Run mode—and the oscilloscope stores at least twice as many samples. At slow sweep speeds, the oscilloscope operates at a higher sample rate when Single is used to capture an acquisition due to the increased memory available. To acquire data with the longest possible record length, press the **Single** key.

Running

When running, versus taking a single acquisition, the memory is divided in half. This allows the acquisition system to acquire one record while processing the previous acquisition, dramatically improving the number of waveforms per second processed by the oscilloscope. While running, maximizing the rate at which waveforms are drawn on the display provides the best picture of your input signal.

To make a single acquisition

When you press the **Single** key it illuminates in yellow and the oscilloscope starts the acquisition system, searching for the trigger condition. When the trigger condition is met, the captured waveform is displayed, the **Single** key is extinguished and the **Run/Stop** key illuminates in red.

Use the **Single** key to view single-shot events without subsequent waveform data overwriting the display.

Use Single when you want the maximum sample rate and the maximum memory depth for pan and zoom. (See “[To pan and zoom](#)” on page 44)

- 1 Set the trigger mode to Normal (see “[Trigger modes: Normal and Auto](#)” on page 91 for instructions).

This keeps the oscilloscope from automatically triggering immediately.

- 2 If you are triggering on analog channel events, turn the Trigger Level knob to the trigger threshold to a level that your waveform will cross.

- 3 To begin a single acquisition, press the **Single** key.

When you press **Single**, the display is cleared, the trigger circuitry is armed, the **Single** key is illuminated yellow, and the oscilloscope will wait until a trigger condition occurs before it displays a waveform.

When the oscilloscope triggers, the single acquisition is displayed and the oscilloscope is stopped (the **Run/Stop** key is illuminated in red).

- 4 To acquire another waveform, press **Single** again.

Auto Single

Auto-trigger will generate a trigger for you if one is not found in the predetermined time (about 40 ms) after you press **Single**. If you want to make a single acquisition and you are not particularly interested in triggering the acquisition (for example, if you are probing a DC level), set the trigger mode to Auto (see [page 91](#)) and press the **Single** key. If a trigger condition occurs, it will be used; if a trigger doesn't happen, an untriggered acquisition will be taken.

To pan and zoom

You can pan across and zoom-in on a waveform even when the acquisition system is stopped.

- 1 Press the **Run/Stop** key to stop acquisitions (or press the **Single** key and allow the oscilloscope to acquire the waveform and stop). The **Run/Stop** key is illuminated red when the oscilloscope is stopped.
- 2 Turn the sweep speed knob to zoom horizontally and turn the volts/division knob to zoom vertically.

The ∇ symbol at the top of the display indicates the time reference point where the zoom-in/zoom-out is referenced.

- 3 Turn the Delay Time knob ($\blacktriangleleft\blacktriangleright$) to pan horizontally and turn the channel's vertical position knob (\blacklozenge) to pan vertically.

The stopped display may contain several triggers worth of information, but only the last trigger acquisition is available for pan and zoom.

For more information about Pan and Zoom see [page 202](#).

Choosing Auto trigger mode or Normal trigger mode

In Auto trigger mode, the oscilloscope automatically triggers and captures waveforms when you press **Run**.

If you press **Run** when the oscilloscope is in Normal trigger mode, a trigger must be detected before an acquisition can complete.

In many cases, a triggered display is not needed to check signal levels or activity. For these applications, use Auto trigger mode (which is the default setting). If you only want to acquire specific events as specified by the trigger settings, use Normal trigger mode.

You can select the trigger mode by pressing the **Mode/Coupling** key, then the **Mode** softkey.

For more detailed discussion of Auto trigger mode and Normal trigger mode, see [“Trigger modes: Normal and Auto”](#) on page 91.

Using Autoscale

To configure the oscilloscope quickly, press the **Autoscale** key to display the connected signal(s) that are active.

To undo the effects of Autoscale, press the **Undo Autoscale** softkey before pressing any other key. This is useful if you have unintentionally pressed the **Autoscale** key or do not like the settings Autoscale has selected and want to return to your previous settings.

Example

Connect the oscilloscope probes for channels 1 and 2 to the Probe Comp output on the front panel of the instrument. Be sure to connect the probe ground leads to the ground lug beside the Probe Comp output. Set the instrument to the factory

default configuration by pressing the **Save/Recall** key, then the **Default Setup** softkey. Then press the **Autoscale** key. You should see a display similar to the one shown below.

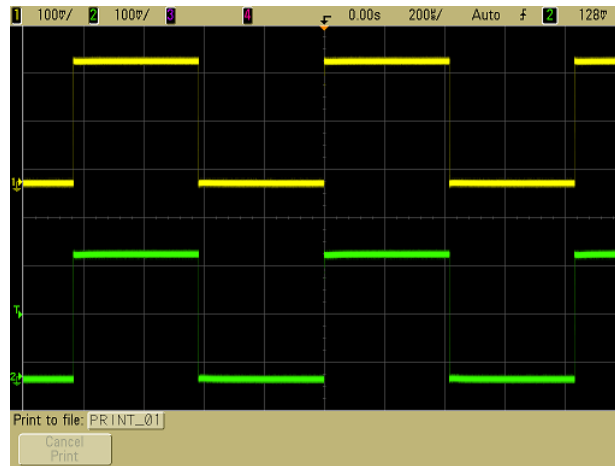

Figure 4 Autoscale of oscilloscope channels 1 and 2

For an explanation of how Autoscale works, see [“How Autoscale Works”](#) on page 243.

To set the probe attenuation factor

Passive Probes

All 6000 Series oscilloscopes including the 100 MHz models recognize passive probes such as the 10073C and 10074C. These probes have a pin on their connector that connects to the ring around the oscilloscope’s BNC connector. Therefore, the oscilloscope will automatically set the attenuation factor for recognized Agilent passive probes.

Passive probes that do not have a pin that connects to the ring around the BNC connector will not be recognized by the oscilloscope, and you must set the probe attenuation factor manually.

Active Probes

All 6000 Series oscilloscopes except the 100 MHz bandwidth models (MSO/DSO6012A and MSO/DSO6014A) have an AutoProbe interface. Most Agilent active probes are compatible with the AutoProbe interface. The AutoProbe interface uses a series of contacts directly below the channel's BNC connector to transfer information between the oscilloscope and the probe. When you connect a compatible probe to the oscilloscope, the AutoProbe interface determines the type of probe and sets the oscilloscope's parameters (units, offset, attenuation, coupling, and impedance) accordingly.

Manually Setting the Probe Attenuation Factor

If you connect a probe that the oscilloscope does not automatically identify, you can set the attenuation factor as follows:

- 1 Press the channel key
- 2 Press the **Probe** softkey
- 3 Turn the Entry knob  to set the attenuation factor for the connected probe.

The attenuation factor can be set from 0.1:1 to 1000:1 in a 1-2-5 sequence. The probe attenuation factor must be set properly for measurements to be made correctly.

Using the analog channels

Connect the oscilloscope probes for channels 1 and 2 to the Probe Comp output on the front panel of the instrument.

- 1 Press the **1** key in the Analog section of the oscilloscope's front panel to display the Channel 1 menu.

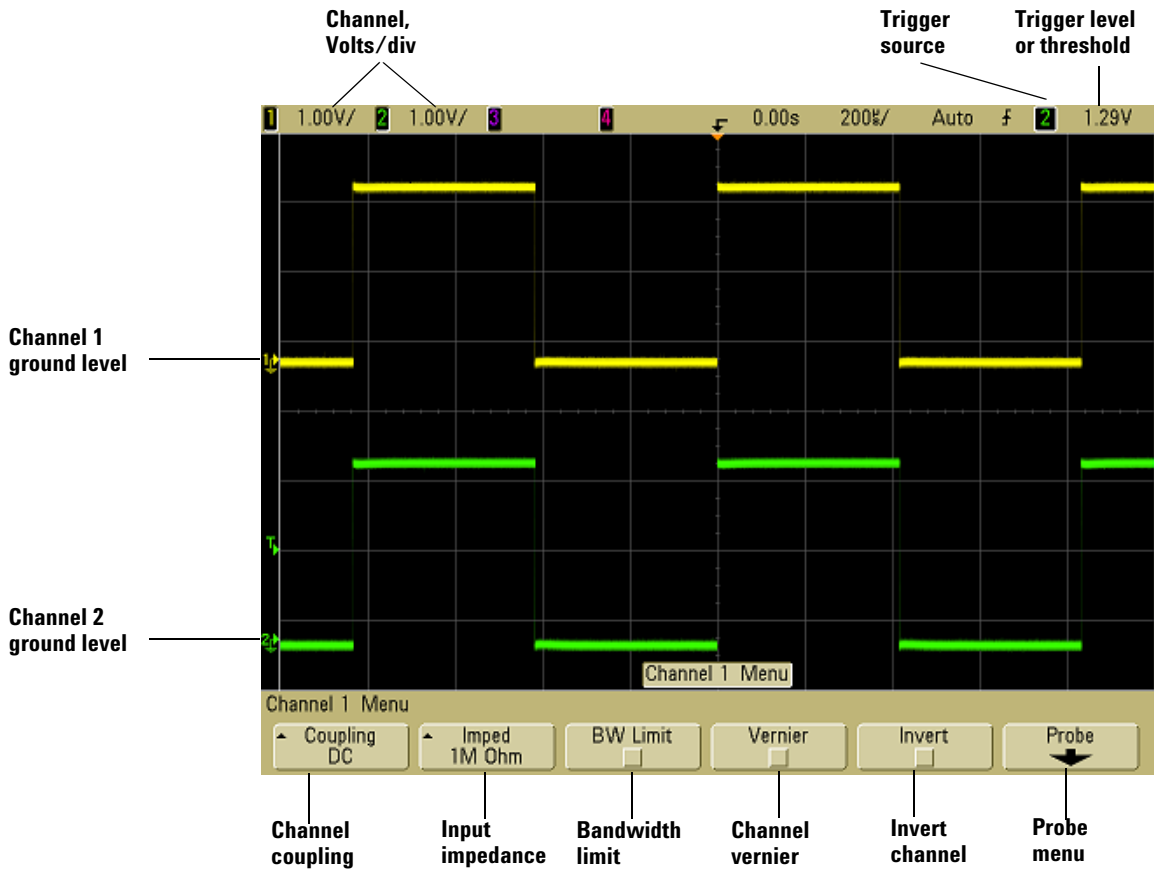

Pressing an analog channel key displays the channel's menu and turns the display of the channel on or off. The channel is displayed when the key is illuminated.

Turning channels off

You must be viewing the menu for a channel before you can turn it off. For example, if channel 1 and channel 2 are turned on and the menu for channel 2 is being displayed, to turn channel 1 off, press **1** to display channel 1 menu, then press **1** again to turn channel 1 off.



Vertical sensitivity Turn the large knob above the channel key to set the sensitivity (volts/division) for the channel. The vertical sensitivity knob changes the analog channel sensitivity in a 1-2-5 step sequence (with a 1:1 probe attached). The analog channel Volts/Div value is displayed in the status line.

Vernier Press the **Vernier** softkey to turn on vernier for the selected channel. When Vernier is selected, you can change the channel's vertical sensitivity in smaller increments. The channel sensitivity remains fully calibrated when Vernier is on. The vernier value is displayed in the status line at the top of the display.

When Vernier is turned off, turning the volts/division knob changes the channel sensitivity in a 1-2-5 step sequence.

Vertical expansion The default mode for expanding the signal when you turn the volts/division knob is vertical expansion about the ground level of the channel. To set the expansion mode to expand about the center of the screen instead, press **Expand** in the **Utility**→**Options**→**Preferences**→**Expand** menu and select **Center**.

Ground level The ground level of the signal for each displayed analog channel is identified by the position of the  icon at the far-left side of the display.

Vertical position Turn the small vertical position knob () to move the channel's waveform up or down on the display. The voltage value momentarily displayed in the upper right portion of the display represents the voltage difference between the vertical center of the display and the ground level () icon. It also represents the voltage at the vertical center of the display if vertical expansion is set to expand about ground.

Measurement Hints

If the channel is DC coupled, you can quickly measure the DC component of the signal by simply noting its distance from the ground symbol.

If the channel is AC coupled, the DC component of the signal is removed, allowing you to use greater sensitivity to display the AC component of the signal.

- 2 Press the channel's on/off key, then press the **Coupling** softkey to select the input channel coupling.

Coupling changes the channel's input coupling to either **AC** (alternating current) or **DC** (direct current). AC coupling places a 3.5 Hz high-pass filter in series with the input waveform that removes any DC offset voltage from the waveform. When **AC** is selected, "AC" is illuminated on the front panel next to the channel position knob (◆).

- DC coupling is useful for viewing waveforms as low as 0 Hz that do not have large DC offsets.
- AC coupling is useful for viewing waveforms with large DC offsets. When AC coupling is chosen, you cannot select 50Ω mode. This is done to prevent damage to the oscilloscope.

Note that Channel Coupling is independent of Trigger Coupling. To change Trigger coupling see [page 93](#).

- 3 Press the **Imped** (impedance) softkey.

NOTE

The input impedance of the MSO/DSO6012A and MSO/DSO6014A (100 MHz bandwidth) oscilloscope is fixed at 1 MΩ. Therefore, the impedance selection is not available on these models.

When you connect an AutoProbe, self-sensing probe, or a compatible InfiniiMax probe, the oscilloscope will automatically configure the oscilloscope to the correct impedance.

The analog channel input impedance can be set to either **1M Ohm** or **50 Ohm** by pressing the **Imped** softkey.

- **50 Ohm** mode matches 50-ohm cables commonly used in making high frequency measurements, and 50-ohm active probes. This impedance matching gives you the most accurate measurements since reflections are minimized along the signal path. When **50 Ohm** is selected, “50Ω” is illuminated on the front panel next to the channel position knob. The oscilloscope automatically switches to **1 M Ohm** mode to prevent possible damage if AC coupling is selected.
- **1M Ohm** mode is for use with many passive probes and for general-purpose measurements. The higher impedance minimizes the loading effect of the oscilloscope on the circuit under test.

4 Press the **BW Limit** softkey to turn on bandwidth limiting.

Pressing the **BW Limit** softkey turns the bandwidth limit on or off for the selected channel. When bandwidth limit is on, the maximum bandwidth for the channel is approximately 25 MHz on the 300 MHz, 500 MHz, and 1 GHz bandwidth oscilloscope models and approximately 20 MHz for the 100 MHz bandwidth oscilloscope models. For waveforms with frequencies below this, turning bandwidth limit on removes unwanted high frequency noise from the waveform. The bandwidth limit also limits the trigger signal path of any channel that has **BW Limit** turned on.

When **BW Limit** is selected, “BW” is illuminated on the front panel next to the channel position knob (◆).

5 Press the **Invert** softkey to invert the selected channel.

When **Invert** is selected, the voltage values of the displayed waveform are inverted. **Invert** affects how a channel is displayed, but does not affect triggering. If the oscilloscope is set to trigger on a rising edge, it remains set to trigger on a same edge (triggers at the same point on the waveform) after the channel is inverted.

Inverting a channel will also change the result of any function selected in the Math menu or any measurement.

6 Press the **Probe** softkey to display the channel probe menu.

This menu lets you select additional probe parameters such as attenuation factor and units of measurement for the connected probe.

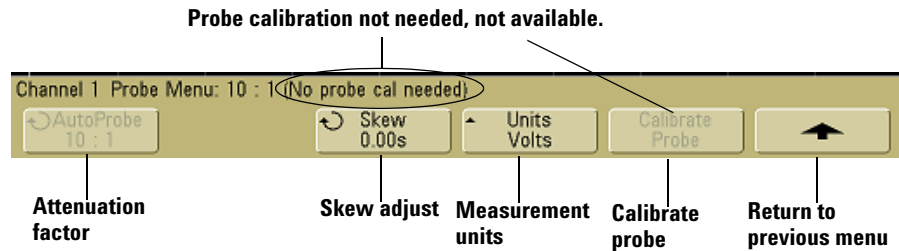

- **Probe Attenuation** – See [“To set the probe attenuation factor”](#) on page 46.
- **Skew** – When measuring time intervals in the ns range, small differences in cable length can affect the measurement. Use **Skew** to remove cable-delay errors between any two channels.

Probe the same point with both probes, then press **Skew** and turn the Entry knob to enter the amount of skew between channels. Each analog channel can be adjusted ± 100 ns in 10 ps increments for a total of 200 ns difference.

The skew setting is reset to zero when you press **Save/Recall** \rightarrow **Default Setup**.

- **Probe Units** – Press the **Units** softkey to select the proper measurement unit for the connected probe. Select **Volts** for a voltage probe and select **Amps** for a current probe. Channel sensitivity, trigger level, measurement results, and math functions will reflect the measurement units you have selected.
- **Calibrate Probe** – See [“To calibrate the probes”](#) on page 25.

To set up the Horizontal time base

- 1 Press the **Main/Delayed** key in the Horizontal section of the front panel.

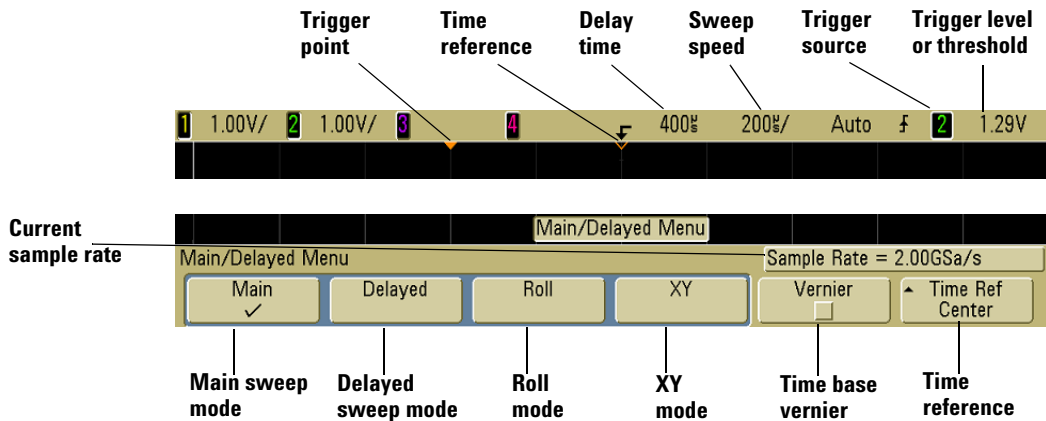

The Main/Delayed menu lets you select the horizontal mode (Main, Delayed, Roll, or XY), and set the time base vernier and time reference.

The current sample rate is displayed above the **Vernier** and **Time Ref** softkeys.

Main mode

- 1 Press the **Main** softkey to select Main horizontal mode.

Main horizontal mode is the normal viewing mode for the oscilloscope. When the oscilloscope is stopped, you can use the Horizontal knobs to pan and zoom the waveform.

- 2 Turn the large knob (time/division) in the Horizontal section and notice the change it makes to the status line.

When the oscilloscope is running in Main mode, use the large Horizontal knob to change sweep speed and use the small knob (◀▶) to set the delay time. When the oscilloscope is stopped, use these knobs to pan and zoom your waveform. The sweep speed (seconds/division) value is displayed in the status line.

- 3 Press the **Vernier** softkey to turn on the time base vernier.

The **Vernier** softkey lets you change the sweep speed in smaller increments with the time/division knob. The sweep speed remains fully calibrated when Vernier is on. The value is displayed in the status line at the top of the display.

When Vernier is turned off, the Horizontal sweep speed knob changes the time base sweep speed in a 1-2-5 step sequence.

- 4 Note the setting of the **Time Ref** (time reference) softkey.

Time reference is the reference point on the display for delay time. Time reference can be set to one major division from the left or right edge, or to the center of the display.

A small hollow triangle (∇) at the top of the display grid marks the position of the time reference. When delay time is set to zero, the trigger point indicator (\blacktriangledown) overlays the time reference indicator.

Turning the Horizontal sweep speed knob will expand or contract the waveform about the time reference point (∇). Turning the Horizontal delay time ($\blacktriangleleft\blacktriangleright$) knob in Main mode will move the trigger point indicator (\blacktriangledown) to the left or right of the time reference point (∇).

The time reference position sets the initial position of the trigger event within acquisition memory and on the display, with delay set to 0. The delay setting sets the specific location of the trigger event with respect to the time reference position. The time reference setting affects the delayed sweep as described in the following ways:

- When the horizontal mode is set to Main, the delay knob positions the main sweep relative to the trigger. This delay is a fixed number. Changing this delay value does not affect the sweep speed.
- When the horizontal mode is set to Delayed, the delay knob controls the position of the delayed sweep window inside the main sweep display. This delay value is independent of sampling interval and sweep speed. Changing this delay value does not effect the position of the main window.

- 5 Turn the delay knob (◀▶) and notice that its value is displayed in the status line.

The delay knob moves the main sweep horizontally, and it pauses at 0.00 s, mimicking a mechanical detent. Changing the delay time moves the sweep horizontally and indicates how far the trigger point (solid inverted triangle) is from the time reference point (hollow inverted triangle ▽). These reference points are indicated along the top of the display grid. The previous figure shows the trigger point with the delay time set to 400 μ s. The delay time number tells you how far the time reference point is located from the trigger point. When delay time is set to zero, the delay time indicator overlays the time reference indicator.

All events displayed left of the trigger point happened before the trigger occurred, and these events are called pre-trigger information. You will find this feature very useful because you can now see the events that led up to the trigger point. Everything to the right of the trigger point is called post-trigger information. The amount of delay range (pre-trigger and post-trigger information) available depends on the sweep speed selected and memory depth.

Delayed mode

Delayed sweep is an expanded version of main sweep. When Delayed mode is selected, the display divides in half and the delayed sweep  icon displays in the middle of the line at the top of the display. The top half of the display shows the main sweep and the bottom half displays the delayed sweep.

Delayed sweep is a magnified portion of the main sweep. You can use delayed sweep to locate and horizontally expand part of the main sweep for a more detailed (higher-resolution) analysis of signals.

The following steps show you how to use delayed sweep. Notice that the steps are very similar to operating the delayed sweep in analog oscilloscopes.

- 1 Connect a signal to the oscilloscope and obtain a stable display.
- 2 Press **Main/Delayed**.
- 3 Press the **Delayed** softkey.

To change the sweep speed for the delayed sweep window, turn the sweep speed knob. As you turn the knob, the sweep speed is highlighted in the status line above the waveform display area.

The area of the main display that is expanded is intensified and marked on each end with a vertical marker. These markers show what portion of the main sweep is expanded in the lower half. The Horizontal knobs control the size and position of the delayed sweep. The delay value is momentarily displayed in the upper-right portion of the display when the delay time (◀▶) knob is turned.

To change the sweep speed for the main sweep window, press the **Main** softkey, then turn the sweep speed knob.

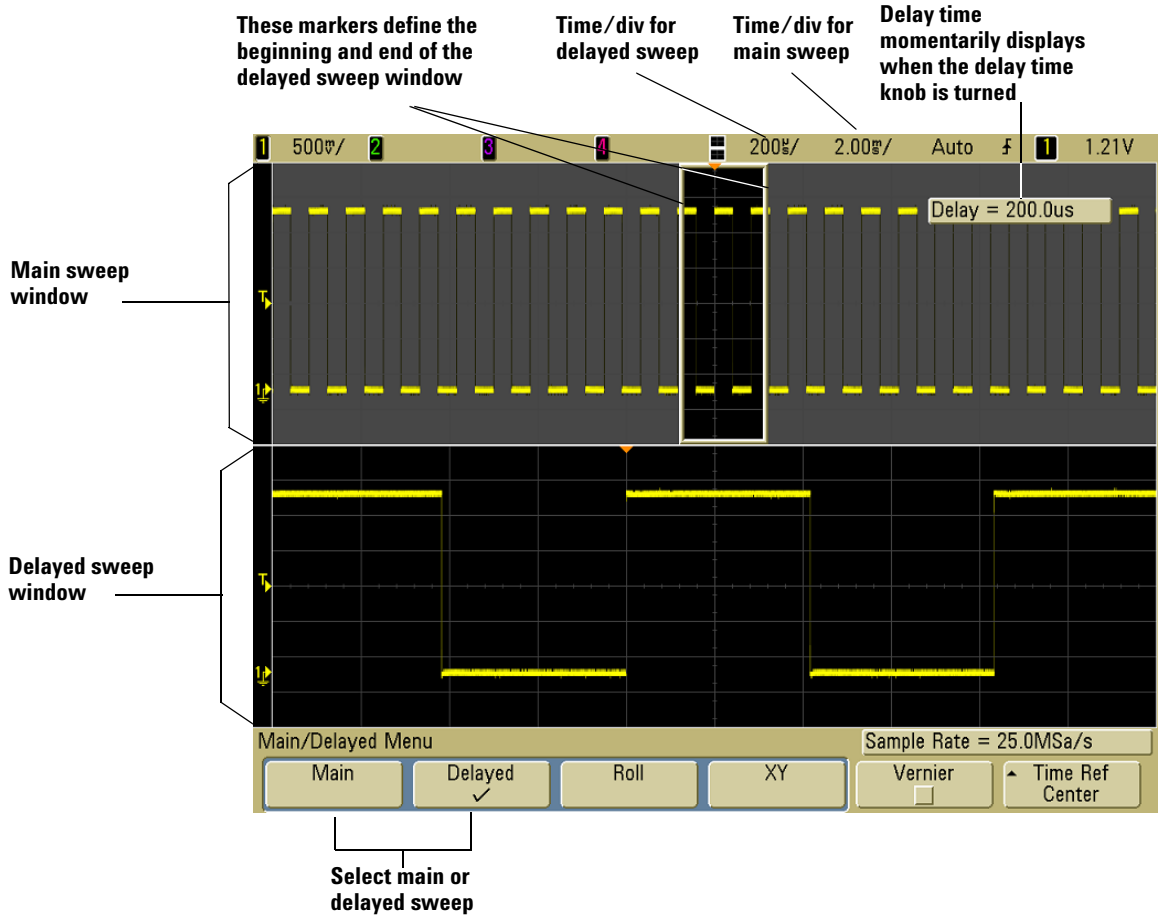

The area of the main display that is expanded is intensified and marked on each end with a vertical marker. These markers show what portion of the main sweep is expanded in the lower half. The Horizontal knobs control the size and position of the delayed sweep. The delay value is momentarily displayed in the upper-right portion of the display when the delay time (◀▶) knob is turned.

To change the sweep speed for the delayed sweep window, turn the sweep speed knob. As you turn the knob, the sweep speed is highlighted in the status line above the waveform display area.

The time reference position sets the initial position of the trigger event within acquisition memory and on the display, with delay set to 0. The delay setting sets the specific location of the trigger event with respect to the time reference position. The time reference setting affects the delayed sweep in the following ways.

When the horizontal mode is set to **Main**, the delay positions the main sweep relative to the trigger. This delay is a fixed number. Changing this delay value does not affect the sweep speed. When the horizontal mode is set to **Delayed**, the delay controls the position of the delayed sweep window inside the main sweep display. This delay value is independent of sampling interval and sweep speed.

To change the sweep speed for the main sweep window, press the **Main** softkey, then turn the sweep speed knob.

For information about using delayed mode for measurements, refer to [Chapter 5](#), “Making Measurements,” starting on page 153.

Roll mode

- Press the **Main/Delayed** key, then press the **Roll** softkey.
- Roll mode causes the waveform to move slowly across the screen from right to left. It only operates on time base settings of 500 ms/div and slower. If the current time base setting is faster than the 500 ms/div limit, it will be set to 500 ms/div when Roll mode is entered.
- In Normal horizontal mode, signal events occurring before the trigger are plotted to the left of the trigger point (t) and signal events after the trigger plotted to the right of the trigger point.

- In Roll mode there is no trigger. The fixed reference point on the screen is the right edge of the screen and refers to the current moment in time. Events that have occurred are scrolled to the left of the reference point. Since there is no trigger, no pre-trigger information is available.

If you would like to pause the display in Roll mode press the **Single** key. To clear the display and restart an acquisition in Roll mode, press the **Single** key again.

Use Roll mode on low-frequency waveforms to yield a display much like a strip chart recorder. It allows the waveform to roll across the display.

XY mode

XY mode changes the display from a volts-versus-time display to a volts-versus-volts display. The time base is turned off. Channel 1 amplitude is plotted on the X-axis and Channel 2 amplitude is plotted on the Y-axis.

You can use XY mode to compare frequency and phase relationships between two signals. XY mode can also be used with transducers to display strain versus displacement, flow versus pressure, volts versus current, or voltage versus frequency.

Use the cursors to make measurements on XY mode waveforms.

For more information about using XY mode for measurements, refer to [“To use the XY horizontal mode”](#) on page 154.

Z-Axis Input in XY Display Mode (Blanking)

When you select the XY display mode, the time base is turned off. Channel 1 is the X-axis input, channel 2 is the Y-axis input, and channel 4 (or the External trigger on 2-channel models) is the Z-axis input. If you only want to see portions of the Y versus X display, use the Z-axis input. Z-axis turns the trace on and off (analog oscilloscopes called this Z-axis blanking because it turned the beam on and off). When Z is low (<1.4 V), Y versus X is displayed; when Z is high (>1.4 V), the trace is turned off.

To make cursor measurements

You can use the cursors to make custom voltage or time measurements on oscilloscope signals, and timing measurements on digital channels.

- 1 Connect a signal to the oscilloscope and obtain a stable display.
- 2 Press the **Cursors** key. View the cursor functions in the softkey menu:
 - **Mode** – Set the cursors to measure voltage and time (Normal), or display the binary or hexadecimal logic value of the displayed waveforms.
 - **Source** – selects a channel or math function for the cursor measurements.
 - **X Y** – Select either the X cursors or the Y cursors for adjustment with the Entry knob.
 - **X1** and **X2** – adjust horizontally and normally measure time.
 - **Y1** and **Y2** – adjust vertically and normally measure voltage.
 - **X1 X2** and **Y1 Y2** – move the cursors together when turning the Entry knob.

NOTE

If you intend to make cursor measurements on a trace that you recall from memory, be sure to recall both setup and trace. See [“To recall traces and setups”](#) on page 260.

For more information about using the cursors, see [“To make cursor measurements”](#) on page 176.

To make automatic measurements

You can use automatic measurements on any channel source or any running math function. Cursors are turned on to focus on the most recently selected measurement (right-most on the measurement line above the softkeys on the display).

- 1 Press the **Quick Meas** key to display the automatic measurement menu.
- 2 Press the **Source** softkey to select the channel or running math function to be measured.

Only channels or math functions that are displayed are available for measurements. If you choose an invalid source channel for a measurement, the measurement will default to the nearest in the list that makes the source valid.

If a portion of the waveform required for a measurement is not displayed or does not display enough resolution to make the measurement, the result will be displayed with a message such as greater than a value, less than a value, not enough edges, not enough amplitude, incomplete, or waveform is clipped to indicate that the measurement may not be reliable.

- 3 Choose a type of measurement by pressing the **Select** softkey, then turn the Entry knob  to select the desired measurement from the popup list.
- 4 Press the **Measure** softkey to make the selected measurement.
- 5 To stop making measurements and erase the measurement results from the measurement line above the softkeys, press the **Clear Meas** softkey.

For more information about automatic measurements, see [“Automatic Measurements”](#) on page 182.

Using Labels

You can define labels and assign them to each analog input channel, or you can turn labels off to increase the waveform display area. Labels can also be applied to digital channels on MSO models.

To turn the label display on or off

- 1 Press the **Label** key on the front panel.

This turns on display labels for the analog and digital channels. When the **Label** key is illuminated, the labels for displayed channels are displayed at the left edge of the displayed traces. The figure below shows an example of the default labels assigned when you turn the label display on. The channel labels default to their channel number.

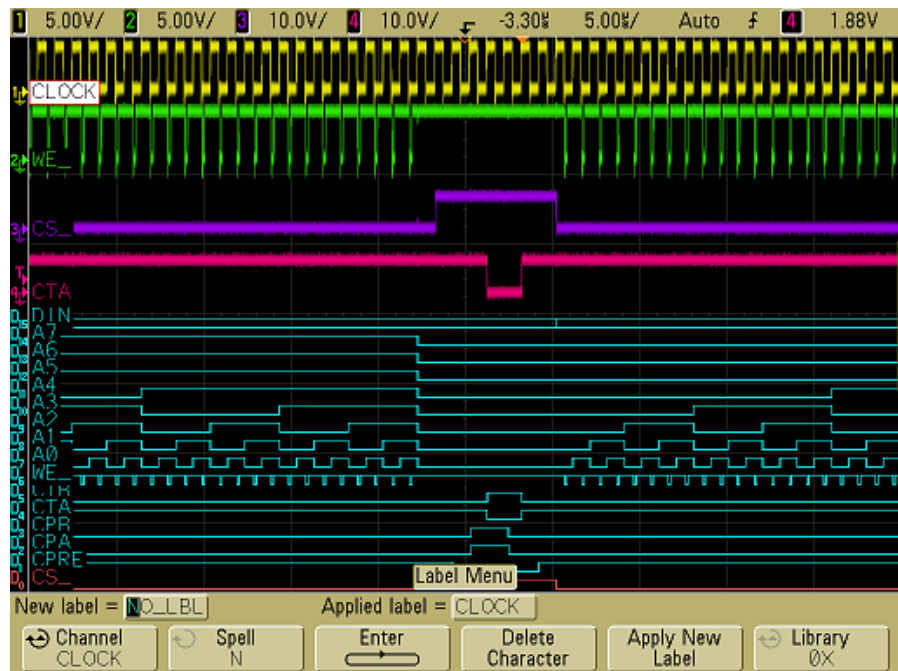

- 2 To turn the labels off, press the **Label** key until it is not illuminated.

To assign a predefined label to a channel

- 1 Press the **Label** key.
- 2 Press the **Channel** softkey, then turn the Entry knob or successively press the **Channel** softkey to select a channel for label assignment.

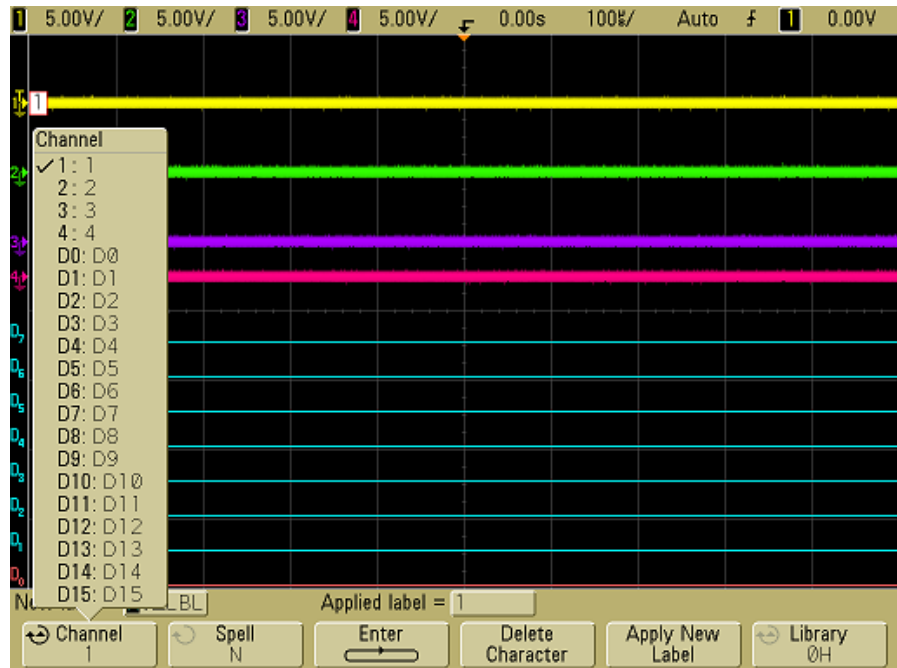

The figure above shows the list of channels and their default labels. The channel does not have to be turned on to have a label assigned to it.

- 3 Press the **Library** softkey, then turn the Entry knob or successively press the **Library** softkey to select a predefined label from the library.
- 4 Press the **Apply New Label** softkey to assign the label to your selected channel.
- 5 Repeat the above procedure for each predefined label you want to assign to a channel.

To define a new label

- 1 Press the **Label** key.
- 2 Press the **Channel** softkey, then turn the Entry knob or successively press the softkey to select a channel for label assignment.

The channel does not have to be turned on to have a label assigned to it. If the channel is turned on, its current label will be highlighted.

- 3 Press the **Spell** softkey, then turn the Entry knob to select the first character in the new label.

Turning the Entry knob selects a character to enter into the highlighted position shown in the "New label =" line above the softkeys and in the **Spell** softkey. Labels can be up to six characters in length.

- 4 Press the **Enter** softkey to enter the selected character and to go to the next character position.

You may position the highlight on any character in the label name by successively pressing the **Enter** softkey.

- 5 To delete a character from the label, press the **Enter** softkey until the letter you want to delete is highlighted, then press the **Delete Character** softkey.
- 6 When you are done entering characters for the label, press the **Apply New Label** softkey to assign the label to the selected channel.

When you define a new label, it is added to the nonvolatile label list.

Label Assignment Auto-Increment Features

When you assign a label ending in a digit, such as ADDR0 or DATA0, the oscilloscope automatically increments the digit and displays the modified label in the "New label" field after you press the **Apply New Label** softkey. Therefore, you only need to select a new channel and press the **Apply New Label** softkey again to assign the label to the channel. Only the original label is saved in the label list. This feature makes it easier to assign successive labels to numbered control lines and data bus lines.

Label List Management

When you press the **Library** softkey, you will see a list of the last 75 labels used. The list does not save duplicate labels. Labels can end in any number of trailing digits. As long as the base string is the same as an existing label in the library, the new label will not be put in the library. For example, if label A0 is in the library and you make a new label called A12345, the new label is not added to the library. When you save a new user-defined label, the new label will replace the oldest label in the list. Oldest is defined as the longest time since the label was last assigned to a channel. Any time you assign any label to a channel, that label will move to the newest in the list. Thus, after you use the label list for a while, your labels will predominate, making it easier to customize the instrument display for your needs.

When you reset the label library list (see next topic), all of your custom labels will be deleted, and the label list will be returned to its factory configuration.

To reset the label library to the factory default

1 Press **Utility**→**Options**→**Preferences**.

CAUTION

Pressing the Default Library softkey will remove all user-defined labels from the library and set the labels back to the factory default. Once deleted, these user-defined labels cannot be recovered.

2 Press the **Default Library** softkey.

This will delete all user-defined labels from the library and set the labels in the library back to the factory default.

However, this does not default the labels currently assigned to the channels (those labels that appear in the waveform area).

Defaulting labels without erasing the default library.

Selecting **Default Setup** in the **Save/Recall** menu will set all channel labels back to the default labels but does not erase the list of user-defined labels in the library.

To print the display

You can print the complete display, including the status line and softkeys, to a USB printer or to a USB mass storage device by pressing the **Quick Print** key. You can stop printing by pressing the **Cancel Print** softkey.

To set up your printer, press **Utility**→**Print Config**.

For more information on printing, see [“To configure printing”](#) on page 246.

To set the clock

The Clock menu lets you set the current date and time of day (24-hour format). This time/date stamp will appear on hardcopy prints and directory information on the USB mass storage device.

To set the date and time, or to view the current date and time:

- 1 Press **Utility**→**Options**→**Clock**.

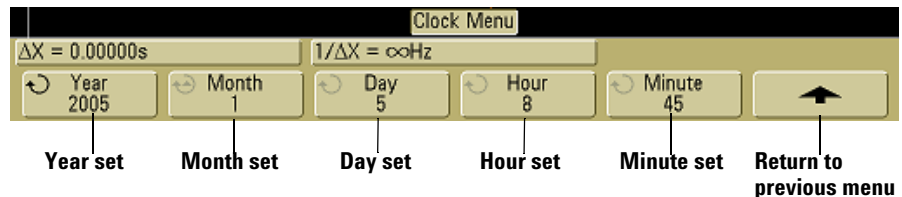

- 2 Press the **Year**, **Month**, **Day**, **Hour** or **Minute** softkey and rotate the Entry knob to set to the desired number.

The hours are shown in the 24-hour format. So 1:00 PM is hour 13.

The real-time clock only allows selection of valid dates. If a day is selected and the month or year is changed so the day is invalid, the day is automatically adjusted.

To set up the screen saver

The oscilloscope can be configured to turn on a display screen saver when the oscilloscope has been idle for a specified length of time.

- 1 Press **Utility**→**Options**→**Preferences**→**Screen Saver** to display the screen saver menu.

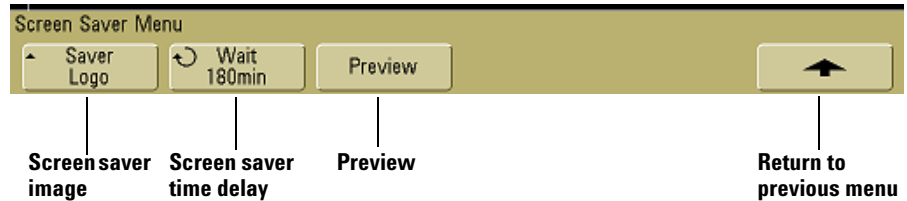

- 2 Press the **Saver** softkey to select the screen saver type.

The screen saver can be set to **Off**, to display any of the images shown in the list, or can display a user-defined text string.

If **User** is selected, press the **Spell** softkey to select the first character of the text string. Use the Entry knob to choose a character. Then press the **Enter** softkey to advance to the next character and repeat the process. The resultant string is displayed in the "Text =" line above the softkeys.

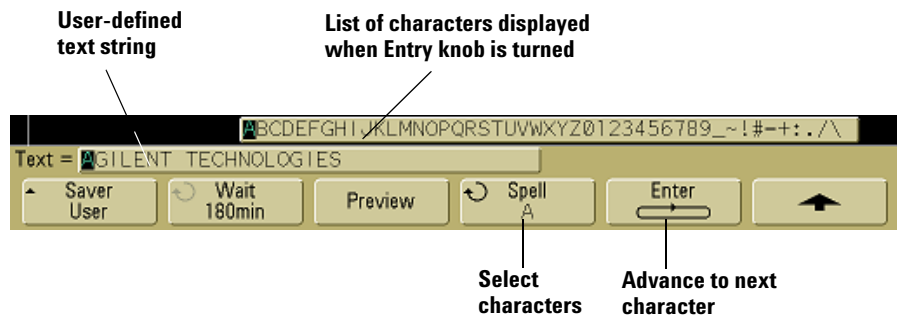

- 3 Turn the Entry knob to select the number of minutes to wait before the selected screen saver activates.

When you turn the Entry knob, the number of minutes is displayed in the **Wait** softkey. The default time is 180 minutes (3 hours).

- 4 Press the **Preview** softkey to preview the screen saver you have selected with the **Saver** softkey.
- 5 To view the normal display after the screen saver has started, press any key or turn any knob.

To set the waveform expansion reference point

- Press **Utility**→**Options**→**Preferences**→**Expand** and select **Ground** or **Center**.

When you change a channel's volts/division setting, the waveform display can be set to expand (or compress) about the signal ground level or the center of the display.

Expand About Ground The displayed waveform will expand about the position of the channel's ground. This is the default setting. The ground level of the signal is identified by the position of the ground level (⏏) icon at the far-left side of the display. The ground level will not move when you adjust the vertical sensitivity (volts/division) control.

If the ground level is off screen, the waveform will expand about the top or bottom edge of the screen based on where the ground is off screen.

Expand About Center The displayed waveform will expand about the center of the display.

To perform service functions

- Press the **Utility**→**Service** to display the service menu.

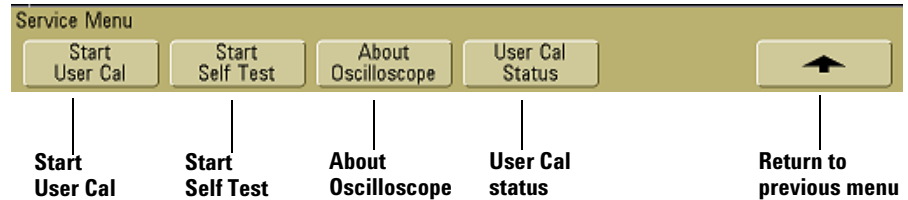

The Service Menu lets you:

- Perform User Cal on the oscilloscope.
- View User Cal status.
- Perform instrument Self Test.
- View information about your oscilloscope model number, code revision information, and User Cal status.

User Calibration

Perform user-calibration:

- Each year or after 2000 hours of operation.
- If the ambient temperature is $>10^{\circ}$ C from the calibration temperature.
- If you want to maximize the measurement accuracy.

The amount of use, environmental conditions, and experience with other instruments help determine if you need shorter User Cal intervals.

User Cal performs an internal self-alignment routine to optimize the signal path in the oscilloscope. The routine uses internally generated signals to optimize circuits that affect channel sensitivity, offset, and trigger parameters. Disconnect all inputs and allow the oscilloscope to warm up before performing this procedure.

Performing User Cal will invalidate your Certificate of Calibration. If NIST (National Institute of Standards and Technology) traceability is required, perform the Performance Verification procedure in the *Agilent 6000 Series Oscilloscopes Service Guide* using traceable sources.

To perform User Cal

- 1 Set the rear-panel CALIBRATION switch to UNPROTECTED.
- 2 Connect short (12 inch maximum) equal length cables to each analog channel's BNC connector on the front of the oscilloscope. You will need two equal-length cables for a 2-channel oscilloscope or four equal-length cables for a 4-channel oscilloscope.

Use 50 Ω RG58AU or equivalent BNC cables when performing User Cal.

For a 2-channel oscilloscope, connect a BNC tee to the equal length cables. Then connect a BNC(f)-to-BNC(f) (also called a barrel connector) to the tee as shown below.

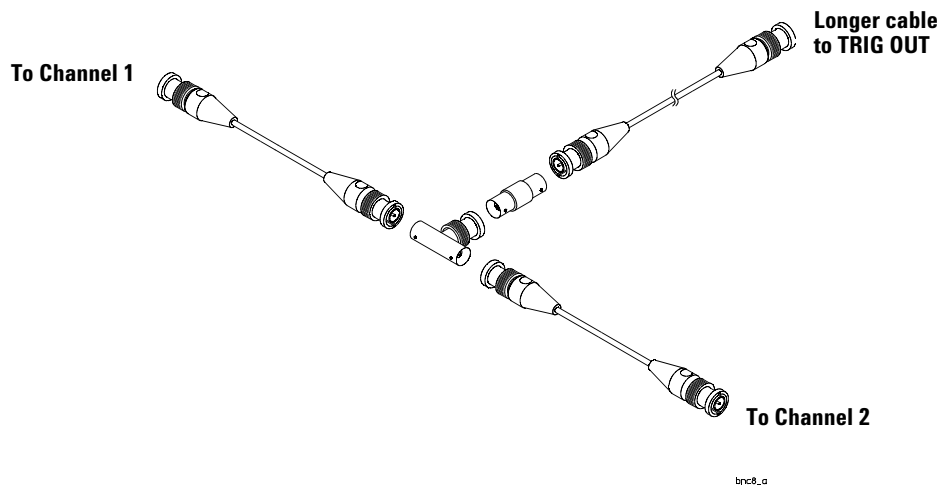

Figure 5 User Calibration cable for 2-channel oscilloscope

For a 4-channel oscilloscope, connect BNC tees to the equal-length cables as shown below. Then connect a BNC(f)-to-BNC(f) (barrel connector) to the tee as shown below.

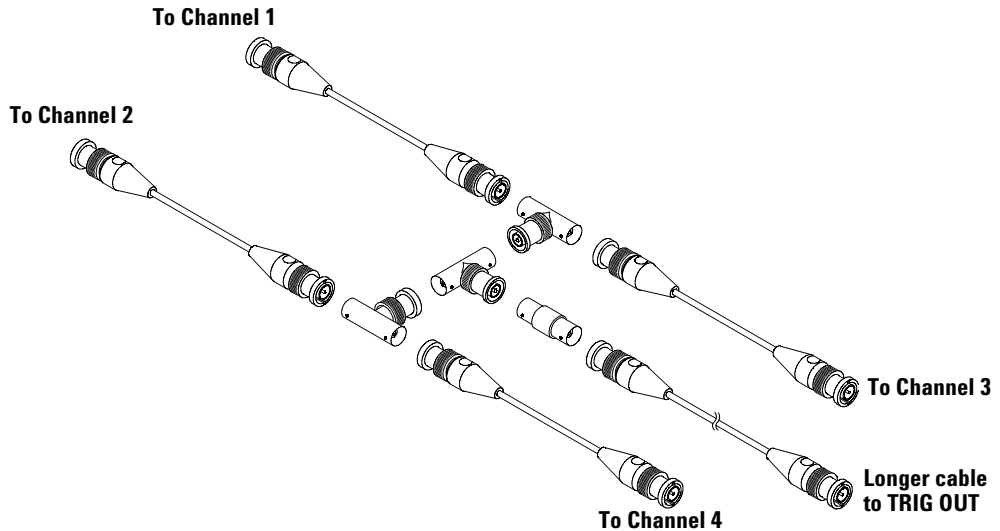

Figure 6 User Calibration cable for 4-channel oscilloscope

- 1 Connect a BNC cable (40 inches maximum) from the TRIG OUT connector on the rear panel to the BNC barrel connector.
- 2 Press the **Utility** key, then press the **Service** softkey.
- 3 Begin the Self Cal by pressing the **Start User Cal** softkey.
- 4 When the User Cal is completed, set the rear-panel CALIBRATION switch to PROTECTED.

User Cal Status

Pressing **Utility**→**Service**→**User Cal Status** displays the summary results of the previous User Cal, and the status of probe calibrations for probes that can be calibrated. Note that passive

probes do not need to be calibrated, but InfiniiMax probes can be calibrated. For more information about calibrating probes see [page 25](#).

Results:

User Cal date:

Change in temperature since last User Cal:

Failure:

Comments:

Probe Cal Status:

Self Test

Pressing **Utility**→**Service**→**Start Self Test** performs a series of internal procedures to verify that the oscilloscope is operating properly.

It is recommended you run Self Test:

- after experiencing abnormal operation.
- for additional information to better describe an oscilloscope failure.
- to verify proper operation after the oscilloscope has been repaired.

Successfully passing Self Test does not guarantee 100% of the oscilloscope's functionality. Self Test is designed to provide an 80% confidence level that the oscilloscope is operating properly.

About Oscilloscope

Pressing **Utility**→**Service**→**About Oscilloscope** displays information about your oscilloscope model number, serial number, software version, boot version, graphics version, and installed licenses.

Installed licenses:

This line in the About This Oscilloscope dialog contains information about the licenses that have been installed on the oscilloscope. For example, it can show:

- **MSO** – Mixed Signal Oscilloscope. This feature adds 16 digital channels without having to install any hardware.
- **LSS** – Low Speed Serial Decode. This license provides serial decode of I²C and SPI buses.
- **AMS** – Automotive Serial Decode. This license provides serial decode of CAN and LIN buses.
- **memXM** – Memory Upgrade. This license provides additional memory, increasing the total memory depth to 2 MB or 8 MB (interleaved).

To restore the oscilloscope to its default configuration

- Press the **Save/Recall** key, then press the **Default Setup** softkey.

The default configuration returns the oscilloscope to its default settings. This places the oscilloscope in a known operating condition. The major default settings are:

Horizontal main mode, 100 μ s/div scale, 0 s delay, center time reference.

Vertical (Analog) Channel 1 on, 5 V/div scale, DC coupling, 0 V position, 1 M Ω impedance, probe factor to 1.0 if an AutoProbe probe is not connected to the channel.

Trigger Edge trigger, Auto sweep mode, 0 V level, channel 1 source, DC coupling, rising edge slope, 60 ns holdoff time.

Display Vectors on, 33% grid intensity, infinite persistence off.

Other Acquire mode normal, Run/Stop to Run, cursors and measurements off.

Labels All custom labels that you have created in the Label Library are preserved (not erased), but all channel labels will be set to their original names.

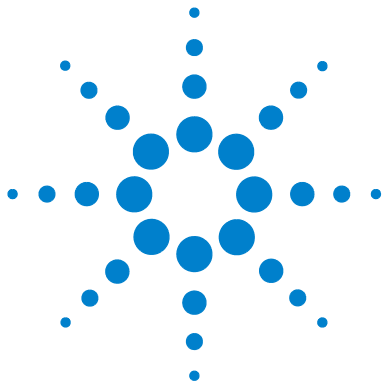

3

Viewing and Measuring Digital Signals

- To connect the digital probes to the circuit under test 76
- Acquiring waveforms using the digital channels 79
- To display digital channels using Autoscale 80
- Interpreting the digital waveform display 82
- To switch all digital channels on or off 83
- To switch groups of channels on or off 83
- To switch a single channel on or off 83
- To change the displayed size of the digital channels 84
- To reposition a digital channel 84
- To change the logic threshold for digital channels 85



To connect the digital probes to the circuit under test

- 1 If you feel it's necessary, turn off the power supply to the circuit under test.

Turning off power to the circuit under test would only prevent damage that might occur if you accidentally short two lines together while connecting probes. You can leave the oscilloscope powered on because no voltage appears at the probes.

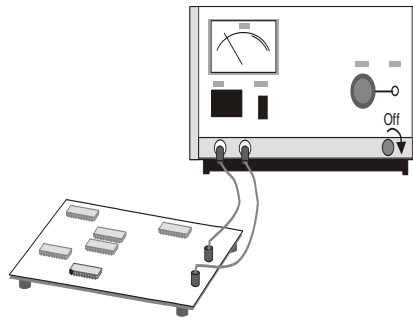

- 2 Connect the digital probe cable to the D15 - D0 connector on the rear panel of the mixed-signal oscilloscope. The digital probe cable is indexed so you can connect it only one way. You do not need to power-off the oscilloscope.
- 3 Route the cable under the oscilloscope and bring it out in front. Lay the two sections of the digital cable on top of each other at the front of the oscilloscope. Slip the narrow end of the cable guide over the cable and into its slots at the front of the oscilloscope. Snap the wide end of the cable guide in place, being careful not to pinch the cable.



CAUTION

Use only the Agilent part number 54620-68701 digital probe kit supplied with the mixed-signal oscilloscope.

- 4 Connect the ground lead on each set of channels (each pod), using a probe grabber. The ground lead improves signal fidelity to the oscilloscope, ensuring accurate measurements.

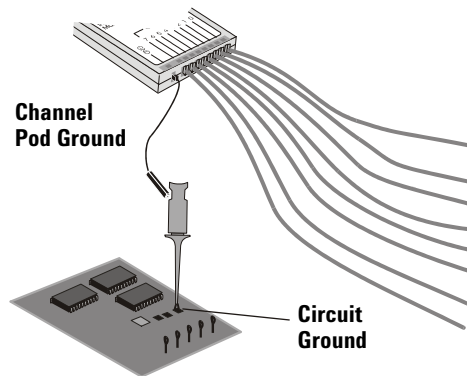

- 5 Connect a grabber to one of the probe leads. (Other probe leads are omitted from the figure for clarity.)

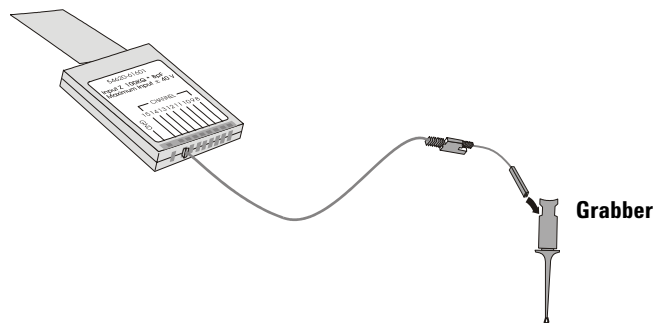

3 Viewing and Measuring Digital Signals

6 Connect the grabber to a node in the circuit you want to test.

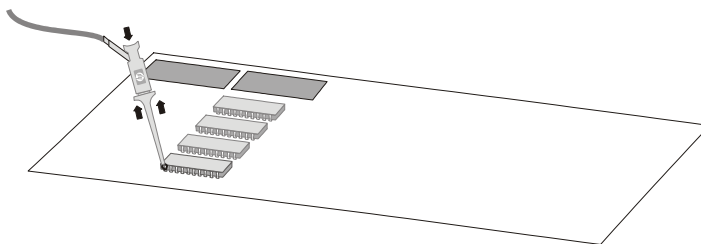

7 For high-speed signals, connect a ground lead to the probe lead, connect a grabber to the ground lead, and attach the grabber to ground in the circuit under test.

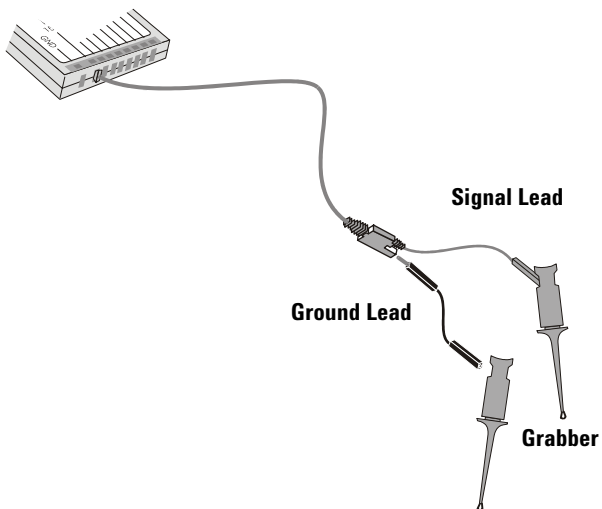

- Repeat steps 3 through 6 until you have connected all points of interest.

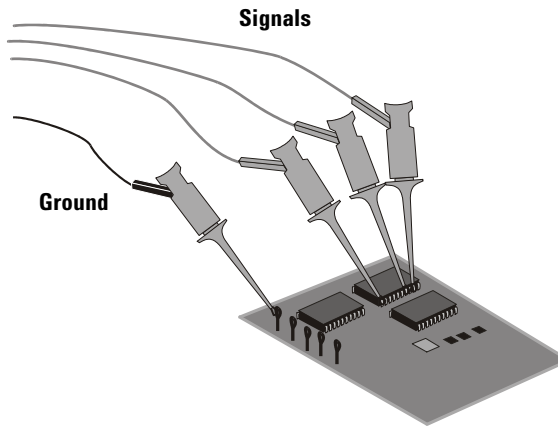

Acquiring waveforms using the digital channels

When you press Run/Stop or Single to run the oscilloscope, the oscilloscope examines the input voltage at each input probe. When the trigger conditions are met the oscilloscope triggers and displays the acquisition.

For digital channels, each time the oscilloscope takes a sample it compares the input voltage to the logic threshold. If the voltage is above the threshold, the oscilloscope stores a 1 in sample memory; otherwise, it stores a 0.

To display digital channels using Autoscale

When signals are connected to the digital channels, Autoscale quickly configures and displays the digital channels.

- To configure the instrument quickly, press the **Autoscale** key.

Any digital channel with an active signal will be displayed. Any digital channels without active signals will be turned off.

- To undo the effects of Autoscale, press the **Undo Autoscale** softkey before pressing any other key.

This is useful if you have unintentionally pressed the **Autoscale** key or do not like the settings Autoscale has selected. This will return the oscilloscope to its previous settings.

For information about how Autoscale works, see [page 243](#).

To set the instrument to the factory-default configuration, press the **Save/Recall** key, then press the **Default Setup** softkey.

Example

Install probe clips on channels 0 and 1 of the digital probe cable. Connect the probes for digital channels 0 and 1 to the Probe Comp output on the front panel of the instrument. Be sure to connect the ground lead to the ground lug beside the Probe Comp output. Set the instrument to the factory default

configuration by pressing the **Save/Recall** key, then the **Default Setup** softkey. Then press the **Autoscale** key. You should see a display similar to the following.

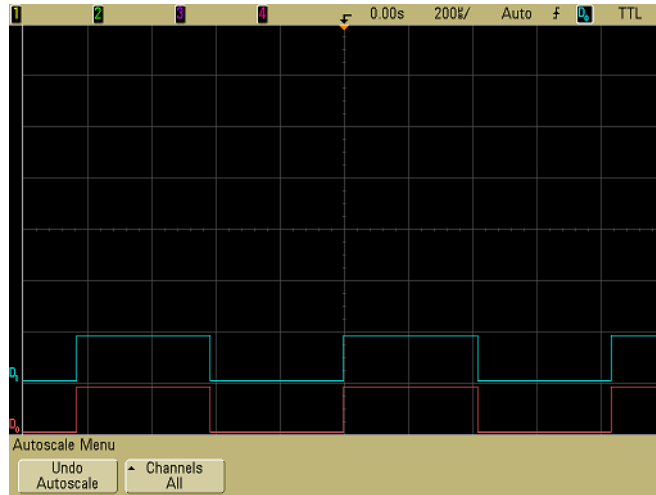
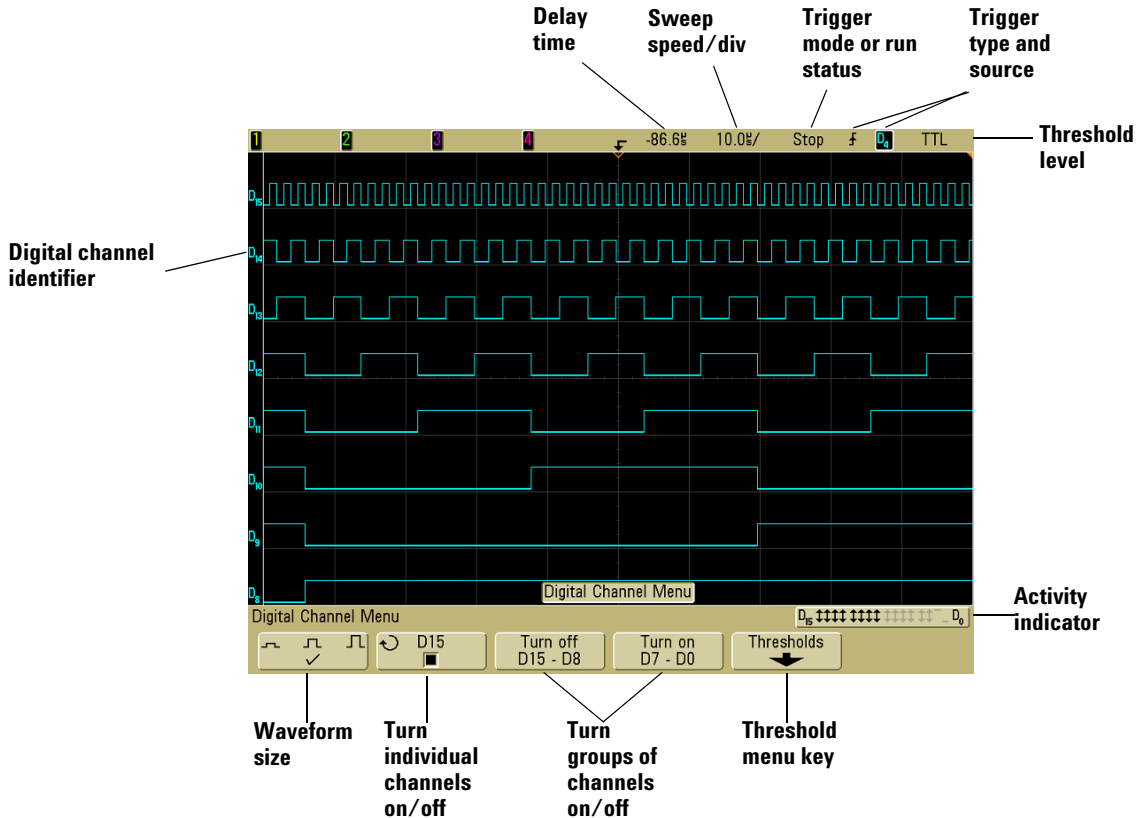

Figure 7 Autoscale of digital channels 0 & 1 (MSO models only)

Interpreting the digital waveform display

The following figure shows a typical display with digital channels.



Activity indicator

When any digital channels are turned on, an activity indicator is displayed in the status line at the bottom of the display. A digital channel can be always high (■), always low (■), or actively toggling logic states (↑↓). Any channel that is turned off will be grayed out in the activity indicator.

To switch all digital channels on or off

- 1 Press the **D15 Thru D0** key to switch the display of the digital channels on or off. The Digital Channel Menu will be displayed above the softkeys.

The digital channels are displayed when this key is illuminated.

If you want to switch the digital channels off, and the Digital Channel Menu is not already displayed, you will have to push the **D15 Thru D0** key twice to switch the digital channels off. The first push displays the Digital Channel Menu, and the second push switches the channels off.

To switch groups of channels on or off



- 1 Press the **D15 Thru D0** key on the front panel if the Digital Channel Menu is not already displayed.
- 2 Press the **Turn off** (or **Turn on**) softkey for the **D15 - D8** group or the **D7 - D0** group.

Each time you press the softkey, the softkey's mode toggles between **Turn on** and **Turn off**.

To switch a single channel on or off

- 1 With the Digital Channel Menu displayed, rotate the Entry knob to select the desired channel from the popup menu.
- 2 Press the softkey that is directly under the popup menu to switch the selected channel on or off.

To change the displayed size of the digital channels

- 1 Press the **D15 Thru D0** key.
- 2 Press the size (  ) softkey to select how the digital channels are displayed.

The sizing control lets you spread out or compress the digital traces vertically on the display for more convenient viewing.

To reposition a digital channel

- 1 The **Digital Select** key is located on the front panel, just to the right of the display. Press either the up symbol or the down symbol on the **Digital Select** key () to select the channel you want to move. The selected channel is highlighted in red.



The “select” feature can also be used to highlight one of the digital channels for easy viewing.

- 2 Press either the up symbol or the down symbol on the **Digital Position** key, which is located below the **Digital Select** and **D15 Thru D0** keys. This moves the displayed channel up or down.

When two or more channels are displayed at the same vertical position, the channel label will be **D***. When you select this position, a pop up will appear showing a list of the overlaid channels. Use the **Digital Select** key to select the desired channel within the pop up. The selected channel will be highlighted in red.

If Labels are turned on, the label of the highlighted signal will appear on top. If none of the signals are highlighted, you will see a bus symbol with a number that indicates how many signals are overlapped.

You can move several channels to a single position to bus several signals together on the display.

Note that the **Digital Select** key () is different from the Entry knob (). The **Digital Select** key is only used to highlight (select) a digital channel for repositioning. The Entry knob's

function changes depending on which menu is displayed. For example, when assigning Labels on digital channels the Entry knob selects the channel to which the Label will be applied.

To change the logic threshold for digital channels

- 1 Press the **D15 Thru D0** key so that the Digital Channel Menu is displayed.
- 2 Press the **Thresholds** softkey
- 3 Press the **D15 - D8** or **D7 - D0** softkey, then select a logic family preset or select **User** to define your own threshold.

Logic family	Threshold Voltage
TTL	+1.4 V
CMOS	+2.5 V
ECL	-1.3 V
User	Variable from -8 V to +8 V

The threshold you set applies to all channels within the selected **D15 Thru D8** or **D7 Thru D0** group. Each of the two channel groups can be set to a different threshold if desired.

Values greater than the set threshold are high (H) and values less than the set threshold are low (L).

If the **Thresholds** softkey is set to **User**, press the **User** softkey for the channel group, then turn the Entry knob to set the logic threshold. There is one **User** softkey for each group of channels.

For advanced information see “[Digital channel signal fidelity: Probe impedance and grounding](#)” on page 271.

For information about replacement parts for the digital probe, see [page 276](#).

3 Viewing and Measuring Digital Signals



4 Triggering the Oscilloscope

Selecting Trigger Modes and Conditions	90
The External Trigger input	96
Trigger Types	99
To use Edge triggering	100
To use Pulse Width triggering	102
To use Pattern triggering	105
To use CAN triggering	107
To use Duration triggering	111
To use I2C triggering	114
To use Nth Edge Burst triggering	120
To use LIN triggering	122
To use Sequence triggering	125
To use SPI triggering	132
To use TV triggering	137
To use USB triggering	149
The Trigger Out connector	151



The Agilent 6000 Series oscilloscopes provide a full set of features to help automate your measurement tasks. MegaZoom technology lets you capture and examine untriggered waveforms. With these oscilloscopes you can:

- Modify the way the oscilloscope acquires data.
- Set up simple or complex trigger conditions as needed, to capture only the sequence of events you want to examine.

Triggering Features

- Trigger modes:
 - Auto
 - Normal
 - Coupling (DC, AC, low frequency rejection)
 - Noise rejection
 - High frequency rejection
- Holdoff
- Trigger Level
- External Trigger input
- Trigger types:
 - Edge (slope)
 - Pulse width (glitch)
 - Pattern
 - CAN
 - Duration
 - I²C
 - Nth Edge Burst
 - LIN
 - Sequence
 - SPI
 - TV
 - USB
- Trigger Out connector

NOTE

Adding the Low Speed Serial (LSS) or Automotive Serial (AMS) serial decode feature to the oscilloscope will add more trigger features to the relevant trigger types (I²C and SPI, or CAN and LIN). See [“Using Serial Decode”](#) on page 215 for more information.

Selecting Trigger Modes and Conditions

The trigger mode affects the way in which the oscilloscope searches for the trigger. The figure below shows the conceptual representation of acquisition memory. Think of the trigger event as dividing acquisition memory into a pre-trigger and post-trigger buffer. The position of the trigger event in acquisition memory is defined by the time reference point and the delay setting.

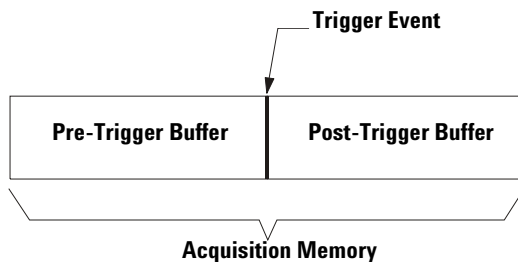
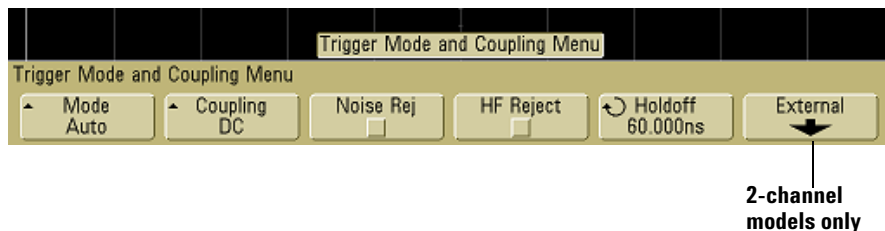

Figure 8 Acquisition Memory

To select the Mode and Coupling menu

- Press the **Mode/Coupling** key in the Trigger section of the front panel.



Trigger modes: Normal and Auto

An introduction to Normal and Auto trigger modes is given on [page 45](#).

- 1 Press the **Mode/Coupling** key.
- 2 Press the **Mode** softkey, then select **Normal** or **Auto**.
 - **Normal** mode displays a waveform when the trigger conditions are met, otherwise the oscilloscope does not trigger and the display is not updated.
 - **Auto** mode is the same as Normal mode, except it forces the oscilloscope to trigger if the trigger conditions are not met.

Auto mode

Use the auto trigger modes for signals other than low-repetitive-rate signals and for unknown signal levels. To display a DC signal, you must use auto trigger mode since there are no edges on which to trigger.

When you select **Run**, the oscilloscope operates by first filling the pre-trigger buffer. It starts searching for a trigger after the pre-trigger buffer is filled, and continues to flow data through this buffer while it searches for the trigger. While searching for the trigger, the oscilloscope overflows the pre-trigger buffer; the first data put into the buffer is the first pushed out (FIFO). When a trigger is found, the pre-trigger buffer will contain the events that occurred just before the trigger. If no trigger is found, the oscilloscope generates a trigger and displays the data as though a trigger had occurred. In this case, the background of the **Auto** indicator at the top of the display will flash, indicating that the oscilloscope is forcing triggers.

When you press the **Single** key, the oscilloscope will fill pre-trigger buffer memory, and continue flowing data through the pre-trigger buffer until the auto trigger overrides the searching and forces a trigger. At the end of the trace, the oscilloscope will stop and display the results.

Normal mode

Use Normal trigger mode for low repetitive-rate signals or when Auto trigger is not required.

In Normal mode the oscilloscope must fill the pre-trigger buffer with data before it will begin searching for a trigger event. The trigger mode indicator on the status line flashes to indicate the oscilloscope is filling the pre-trigger buffer. While searching for the trigger, the oscilloscope overflows the pre-trigger buffer; the first data put into the buffer is the first pushed out (FIFO).

When the trigger event is found, the oscilloscope will fill the post-trigger buffer and display the acquisition memory. If the acquisition was initiated by **Run/Stop**, the process repeats. If the acquisition was initiated by pressing **Single**, then the acquisition stops and you can Pan and Zoom the waveform.

In either Auto or Normal mode, the trigger may be missed completely under certain conditions. This is because the oscilloscope will not recognize a trigger event until the pre-trigger buffer is full. Suppose you set the Time/Div knob to a slow sweep speed, such as 500 ms/div. If the trigger condition occurs before the oscilloscope has filled the pre-trigger buffer, the trigger will not be found. If you use Normal mode and wait for the trigger condition indicator to flash before causing the action in the circuit, the oscilloscope will always find the trigger condition.

Some measurements you want to make will require you to take some action in the circuit under test to cause the trigger event. Usually, these are single-shot acquisitions, where you will use the **Single** key.

To select trigger Coupling

- 1 Press the **Mode/Coupling** key.
- 2 Press the **Coupling** softkey, then select **DC**, **AC**, or **LF Reject** coupling.
 - **DC** coupling allows DC and AC signals into the trigger path.
 - **AC** coupling places a 10 Hz (3.5 Hz in 100 MHz bandwidth models) high-pass filter in the trigger path removing any DC offset voltage from the trigger waveform. The high-pass filter in the External Trigger input path is 3.5 Hz for all models. Use AC coupling to get a stable edge trigger when your waveform has a large DC offset.
 - **LF** (low frequency) **Reject** coupling places a 50 kHz high-pass filter in series with the trigger waveform. Low frequency reject removes any unwanted low frequency components from a trigger waveform, such as power line frequencies, that can interfere with proper triggering. Use this coupling to get a stable edge trigger when your waveform has low frequency noise.
 - **TV** coupling is normally grayed-out, but is automatically selected when TV trigger is enabled in the Trigger More menu.

Note that Trigger Coupling is independent of Channel Coupling. To change Channel Coupling see [page 50](#).

To select trigger Noise Rejection and HF rejection

- 1 Press the **Mode/Coupling** key.
- 2 Press the **Noise Rej** softkey to select noise reject or press the **HF Reject** softkey to select high frequency reject.
 - **Noise Rej** adds additional hysteresis to the trigger circuitry. When noise reject is on, the trigger circuitry is less sensitive to noise but may require a greater amplitude waveform to trigger the oscilloscope.

- **HF Reject** adds a 50 kHz low-pass filter in the trigger path to remove high frequency components from the trigger waveform. You can use HF Reject to remove high-frequency noise, such as AM or FM broadcast stations or noise from fast system clocks, from the trigger path.

To set Holdoff

- 1 Press the **Mode/Coupling** key.
- 2 Turn the Entry knob  to increase or decrease the trigger holdoff time shown in the **Holdoff** softkey.

Holdoff sets the amount of time that the oscilloscope waits before re-arming the trigger circuitry. Use Holdoff to stabilize the display of complex waveforms.

To get a stable trigger on the pulse burst shown below, set the holdoff time to be >200 ns but <600 ns.

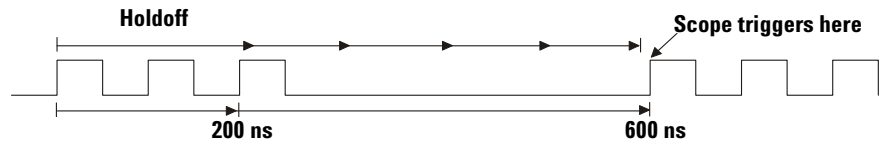

By setting the Holdoff, you can synchronize triggers. The oscilloscope will trigger on one edge of the waveform, and ignore further edges until the holdoff time expires. The oscilloscope will then re-arm the trigger circuit to search for the next edge trigger. This allows the oscilloscope to trigger on a repeating pattern in a waveform.

Holdoff Operating Hints

Holdoff keeps a trigger from occurring until after a certain amount of time has passed since the last trigger. This feature is valuable when a waveform crosses the trigger level multiple times during one period of the waveform.

Without holdoff, the oscilloscope could trigger on each of the crossings, producing a confusing waveform. With holdoff set correctly, the oscilloscope always triggers on the same crossing. The correct holdoff setting is typically slightly less than one period. Set the holdoff to this time to generate a unique trigger point. This action works even though many waveform periods pass between triggers, because the holdoff circuit operates on the input signal continuously.

Changing the time base settings does not affect the holdoff number. In contrast, the holdoff in analog oscilloscopes is a function of the time base setting, making it necessary to readjust the holdoff each time you change the time base setting.

With Agilent's MegaZoom technology, you can press **Stop**, then pan and zoom through the data to find where it repeats. Measure this time using the cursors, then set the holdoff.

The External Trigger input

The External Trigger input can be used as a source in several of the trigger types.

On 2-channel oscilloscopes, the external trigger BNC input is on the front panel and is labeled **Ext Trigger**.

On 4-channel oscilloscopes, the external trigger BNC input is on the rear panel and is labeled **Ext Trig**.

For trigger system specifications, see [page 290](#).

2-Channel oscilloscope External Trigger input

External Trigger Probe Settings

You can set external trigger probe parameters as described below.

- 1 Press the **Mode/Coupling** key in the Trigger section of the front panel.

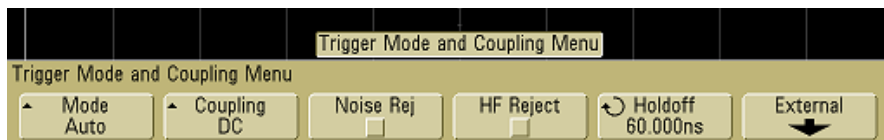

- 2 Press the **External** softkey to display the external trigger probe menu.

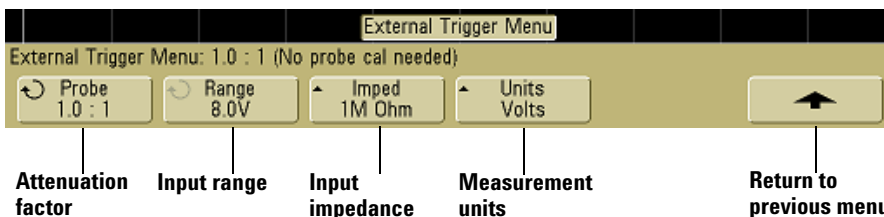

Probe Attenuation Turn the Entry knob to set the attenuation factor displayed in the **Probe** softkey for the connected probe. The attenuation factor can be set from 0.1:1 to 1000:1 in a 1-2-5 sequence.

When you connect an AutoProbe self-sensing probe, the oscilloscope will automatically configure your probe to the correct attenuation factor. Note that the AutoProbe feature is not available on 100 MHz bandwidth models.

The probe correction factor must be set properly for measurements to be made correctly.

Range The input voltage range can be set to 1.0 Volts or 8.0 Volts. When in current mode, the range is fixed at 1.0 Amps. Maximum input voltage for the external trigger input of the 2-channel oscilloscope:

CAUTION

Maximum input voltage for analog inputs:

CAT I 300 Vrms, 400 Vpk; transient overvoltage 1.6 kVpk

CAT II 100 Vrms, 400 Vpk

with 10073C or 10074C 10:1 probe: CAT I 500 Vpk, CAT II 400 Vpk

CAUTION

Do not exceed 5 Vrms in 50 Ω mode on the 2-channel models. Input protection is enabled in 50 Ω mode and the 50 Ω load will disconnect if greater than 5 Vrms is detected. However the input could still be damaged, depending on the time constant of the signal.

CAUTION

The 50 Ω input protection mode only functions when the oscilloscope is powered on.

Input Impedance The 300 MHz, 500 MHz, and 1 GHz bandwidth 2-channel oscilloscopes have selectable external trigger input impedance. The impedance can be set to either **1M Ohm** or **50 Ohm** by pressing the **Imped** softkey. The input impedance of 100 MHz bandwidth models is fixed at 1M Ω

- **50 Ohm** mode matches 50-ohm cables commonly used in making high frequency measurements. This impedance matching gives you the most accurate measurements since reflections are minimized along the signal path.
- **1M Ohm** mode is for use with many passive probes and for general-purpose measurements. The higher impedance minimizes the loading effect of the oscilloscope on the circuit under test.

Probe Units Press the **Units** softkey to select the proper measurement unit for the connected probe. Select **Volts** for a voltage probe and select **Amps** for a current probe. Measurement results, channel sensitivity, and trigger level will reflect the measurement units you have selected.

4-Channel oscilloscope External Trigger input

Input Impedance The external trigger input impedance for the 4-channel oscilloscope is approximately 2.14 k Ω (~1.015 k Ω on 100 MHz bandwidth models).

Input Voltage The input voltage sensitivity is 500 mV, from DC to 500 MHz (DC to 100 MHz on 100 MHz bandwidth models). The input voltage range is ± 15 V.



CAUTION

Do not exceed 15 Vrms at rear panel External Trigger input or damage to the oscilloscope may occur.

There are no range or units settings for the External Trigger input of the 4-channel oscilloscope.

Trigger Types

The oscilloscope lets you synchronize the display to the actions of the circuit under test by defining a trigger condition. You can use any input channel or the Ext Trigger BNC as the source for most trigger types.

MegaZoom Technology Simplifies Triggering

With the built-in MegaZoom technology, you can simply Autoscale the waveforms, then stop the oscilloscope to capture a waveform. You can then pan and zoom through the data using the Horizontal and Vertical knobs to find a stable trigger point. Autoscale often produces a triggered display.

These trigger types are available and are presented in the following order in this chapter:

- Edge trigger
- Pulse Width (glitch) trigger
- Pattern trigger
- CAN (Controller Area Network) trigger
- Duration trigger
- I²C (Inter-IC bus) trigger
- Nth Edge Burst trigger
- LIN (Local Interconnect Network)
- Sequence trigger
- SPI (Serial Peripheral Interface) trigger
- TV trigger
- USB (Universal Serial Bus) trigger

Changes to the trigger specification are applied when you make them. If the oscilloscope is stopped when you change a trigger specification, the oscilloscope will use the new specification when you press **Run/Stop** or **Single**. If the oscilloscope is running when you change a triggering specification, it uses the new trigger definition when it starts the next acquisition.

To use Edge triggering

The Edge trigger type identifies a trigger by looking for a specified edge (slope) and voltage level on a waveform. You can define the trigger source and slope in this menu. The slope can be set to rising edge or falling edge, and can be set to alternating edges or either edge on all sources except Line. The trigger type, source, and level are displayed in the upper-right corner of the display.

- 1 Press the **Edge** key in the Trigger section of the front panel to display the Edge trigger menu.

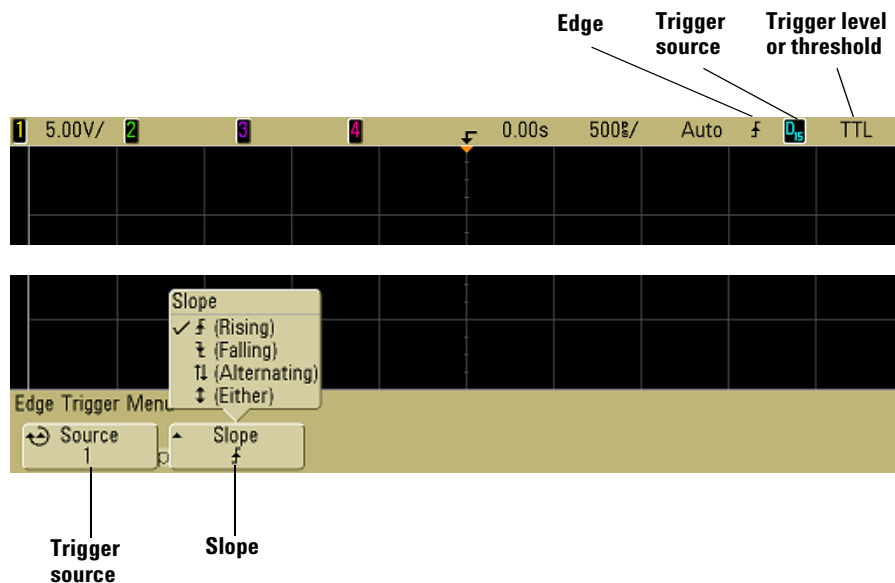

- 2 Press the **Slope** softkey and select rising edge, falling edge, alternating edges, or either edge. The selected slope is displayed in the upper-right corner of the display.

NOTE

Alternating edge mode is useful when you want to trigger on both edges of a clock (for example, DDR signals). Either edge mode is useful when you want to trigger on any activity of a selected source. All modes operate up to the bandwidth of the oscilloscope except Either edge mode, which has a limitation. Either edge mode will trigger on Constant Wave signals up to 100 MHz, but can trigger on isolated pulses down to $1/(2 \times \text{oscilloscope's bandwidth})$.

3 Select the trigger source.

You can select analog channel 1 or 2, Ext, or Line as the trigger source on any Agilent 6000 Series oscilloscope. The trigger source can also be set to channel 3 and 4 on the 4-channel oscilloscopes, or digital channels D15 through D0 on the mixed-signal oscilloscopes. You can choose a channel that is turned off (not displayed) as the source for the edge trigger.

The selected trigger source is indicated in the upper-right corner of the display next to the slope symbol:

1 through **4** = analog channels

D0 through **D15** = digital channels

E = External trigger

L = Line trigger

Trigger level adjustment

You can adjust the trigger level for a selected analog channel by turning the Trigger Level knob. The position of the trigger level for the analog channel is indicated by the trigger level icon  (if the analog channel is on) at the far left side of the display when DC coupling is selected. The value of the analog channel trigger level is displayed in the upper-right corner of the display.

The trigger level for a selected digital channel is set using the threshold menu in the Digital Channel Menu. Press the **D15 Thru D0** key on the front panel, then press the **Thresholds** softkey to

4 Triggering the Oscilloscope

set the threshold level (TTL, CMOS, ECL, or user defined) for the selected digital channel group. The threshold value is displayed in the upper-right corner of the display.

When **Ext** (External Trigger) is selected, its level can be adjusted using the **Level** knob in the Trigger section of the front panel. The trigger level is displayed in the upper right corner of the display.

The line trigger level is not adjustable. This trigger is synchronized with the power line supplied to the oscilloscope.

To use Pulse Width triggering

Pulse Width (glitch) triggering sets the oscilloscope to trigger on a positive or negative pulse of a specified width. If you want to trigger on a specific timeout value, use **Duration** trigger in the Trigger **More** menu.

- 1 Press the **Pulse Width** key in the Trigger section of the front panel to display the Pulse Width trigger menu.

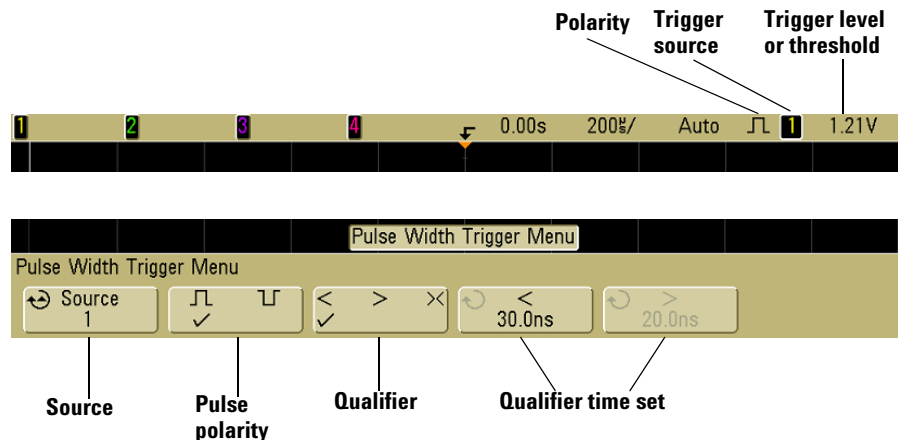

- 2 Press the **Source** softkey (or rotate the Entry knob on mixed-signal oscilloscopes) to select a channel source for the trigger.

The channel you select is shown in the upper-right corner of the display next to the polarity symbol.

The source can be any analog or digital channel available on your oscilloscope. External trigger may also be specified as a source when using a 2-channel oscilloscope.

Adjust the trigger level for the selected analog channel by turning the Trigger Level knob. Press the **D15 Thru D0** key and select **Thresholds** to set the threshold level for digital channels. The value of the trigger level or digital threshold is displayed in the upper-right corner of the display.

- 3 Press the pulse polarity softkey to select positive (⌋) or negative (⌋) polarity for the pulse width you want to capture.

The selected pulse polarity is displayed in the upper-right corner of the display. A positive pulse is higher than the current trigger level or threshold and a negative pulse is lower than the current trigger level or threshold.

When triggering on a positive pulse, the trigger will occur on the high to low transition of the pulse if the qualifying condition is true. When triggering on a negative pulse, the trigger will occur on the low to high transition of the pulse if the qualifying condition is true.

- 4 Press the qualifier softkey (< > ><) to select the time qualifier.

The Qualifier softkey can set the oscilloscope to trigger on a pulse width that is:

- less than a time value (<).

For example, for a positive pulse, if you set $t < 10$ ns:



- greater than a time value (>).

4 Triggering the Oscilloscope

For example, for a positive pulse, if you set $t > 10$ ns:



- within a range of time values ($><$).

For example, for a positive pulse, if you set $t > 10$ ns and $t < 15$ ns:

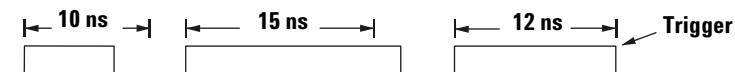

- 5 Select the qualifier time set softkey ($<$ or $>$), then rotate the Entry knob to set the pulse width qualifier time.

The qualifiers can be set as follows:

- 2 ns to 10 s for $>$ or $<$ qualifier (5 ns to 10 s for 100 MHz and 300 MHz bandwidth models)
- 10 ns to 10 s for $><$ qualifier, with minimum difference of 5 ns between upper and lower settings

$<$ qualifier time set softkey

- When the less than ($<$) qualifier is selected, the Entry knob sets the oscilloscope to trigger on a pulse width less than the time value displayed on the softkey.
- When the time range ($><$) qualifier is selected, the Entry knob sets the upper time range value.

$>$ qualifier time set softkey

- When the greater than ($>$) qualifier is selected, the Entry knob sets the oscilloscope to trigger on a pulse width greater than the time value displayed on the softkey.
- When the time range ($><$) qualifier is selected, the Entry knob sets the lower time range value.

To use Pattern triggering

The Pattern trigger identifies a trigger condition by looking for a specified pattern. This pattern is a logical AND combination of the channels. Each channel can have a value of high (H), low (L), don't care (X). A rising or falling edge can be specified for one channel included in the pattern.

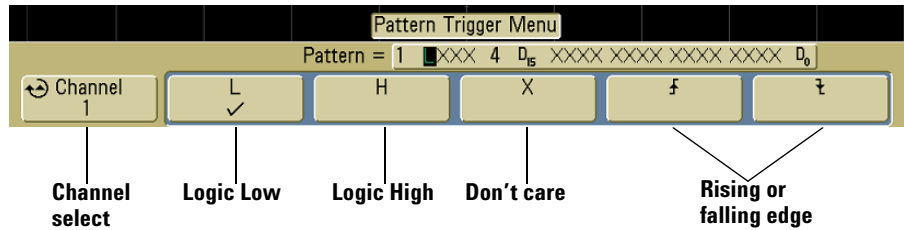
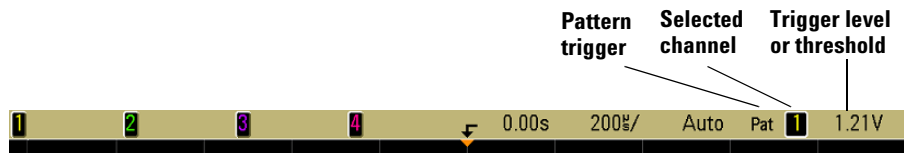

- 1 Press the **Pattern** key in the Trigger section of the front panel to display the Pattern trigger menu.



- 2 For each analog or digital channel you want to include in the desired pattern, press the **Channel** softkey to select the channel.

This is the channel source for the H, L, X, or edge condition. As you press the **Channel** softkey (or rotate the Entry knob on mixed-signal oscilloscopes), the channel you select is highlighted in the **Pattern =** line directly above the softkeys and in the upper-right corner of the display next to “**Pat**”. External trigger may also be specified as a channel in the pattern when using the 2-channel and 4-channel oscilloscopes.

Adjust the trigger level for the selected analog channel by turning the Trigger Level knob. Press the **D15 Thru D0** key and select **Thresholds** to set the threshold level for digital channels. The value of the trigger level or digital threshold is displayed in the upper-right corner of the display.

- 3** For each channel you select, press one of the condition softkeys to set the condition for that channel in the pattern.
- **H** sets the pattern to high on the selected channel. A high is a voltage level that is greater than the channel's trigger level or threshold level.
 - **L** sets the pattern to low on the selected channel. A low is a voltage level that is less than the channel's trigger level or threshold level.
 - **X** sets the pattern to don't care on the selected channel. Any channel set to don't care is ignored and is not used as part of the pattern. However, if all channels in the pattern are set to don't care, the oscilloscope will not trigger.
 - The rising edge () or falling edge () falling edge softkey sets the pattern to an edge on the selected channel. Only one rising or falling edge can be specified in the pattern. When an edge is specified, the oscilloscope will trigger at the edge specified if the pattern set for the other channels is true.

If no edge is specified, the oscilloscope will trigger on the last edge that makes the pattern true.

Specifying an Edge in a Pattern

You are allowed to specify only one rising or falling edge term in the pattern. If you define an edge term, then select a different channel in the pattern and define another edge term, the previous edge definition is changed to a don't care.

To use CAN triggering

NOTE

For CAN decode setup see [page 225](#).

Controller Area Network (CAN) trigger will trigger on CAN version 2.0A and 2.0B signals. Setup consists of connecting the oscilloscope to a CAN signal, using the **Settings** menu to specify the event to trigger on, and using the **Signals** menu to specify the signal source, baud rate, and sample point.

The oscilloscope will trigger on dominant-low CAN signals. If you are connecting to the CAN signal using a differential probe, connect the probe's positive lead to the dominant-low CAN signal (CAN_L) and connect the negative lead to the dominant-high CAN signal (CAN_H).

The CAN trigger will trigger on the Start of Frame (SOF) bit of a data frame. If the N5424A CAN/LIN Automotive Triggering and Decode option is installed on your oscilloscope, the following additional CAN trigger types will also be available: Remote Frame ID (RTR), Data Frame ID (~RTR), Remote or Data Frame ID, Data Frame ID and Data, Error Frame, All Errors, Acknowledge Error, and Overload Frame.

A CAN message frame in CAN_L signal type is shown below:

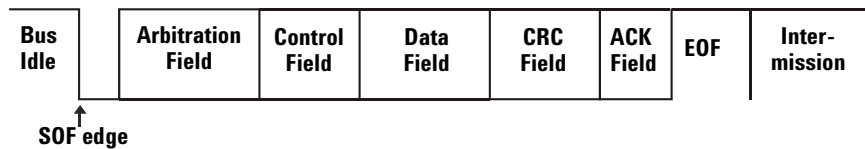

- 1 Press the **More** key in the Trigger section of the front panel, rotate the Entry knob until **CAN** is displayed in the **Trigger**

4 Triggering the Oscilloscope

softkey, then press the **Settings** softkey to display CAN trigger menu.

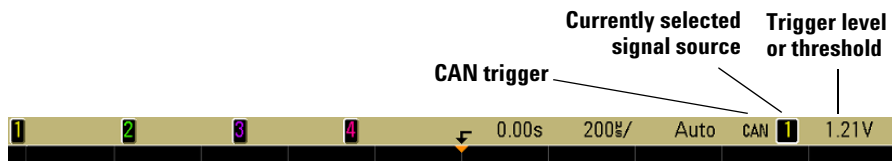

- 2 Repeatedly press and release the **Trigger:** softkey or rotate the Entry knob to select the trigger condition.
 - **SOF - Start of Frame** – The oscilloscope triggers at the start of a frame.
 - **Remote Frame ID (RTR)** – The oscilloscope triggers on remote frames with the specified ID. Press the **Bits** softkey to select the ID. For details about using the Bits softkeys, press and hold the softkey in question to display the built-in help for this subject.
 - **Data Frame ID (~RTR)** - The oscilloscope will trigger on data frames matching the specified ID. Press the **Bits** softkey to select the ID.
 - **Remote or Data Frame ID** - The oscilloscope will trigger on remote or data frames matching the specified ID. Press the **Bits** softkey to select the ID.
 - **Data Frame ID and Data** - The oscilloscope will trigger on data frames matching the specified ID and data. Press the **Bits** softkey to select the ID and set up the number of data bytes and values.

- **Error Frame** - The oscilloscope will trigger on CAN active error frames.
 - **All Errors** - The oscilloscope will trigger when any form error or active error is encountered.
 - **Acknowledge Error** - The oscilloscope will trigger when the acknowledge bit is recessive (high).
 - **Overload Frame** - The oscilloscope will trigger on CAN overload frames.
- 3 If necessary, press the up-arrow softkey to return to the CAN Trigger menu. Press the **Signals** softkey to enter the CAN Signals menu.

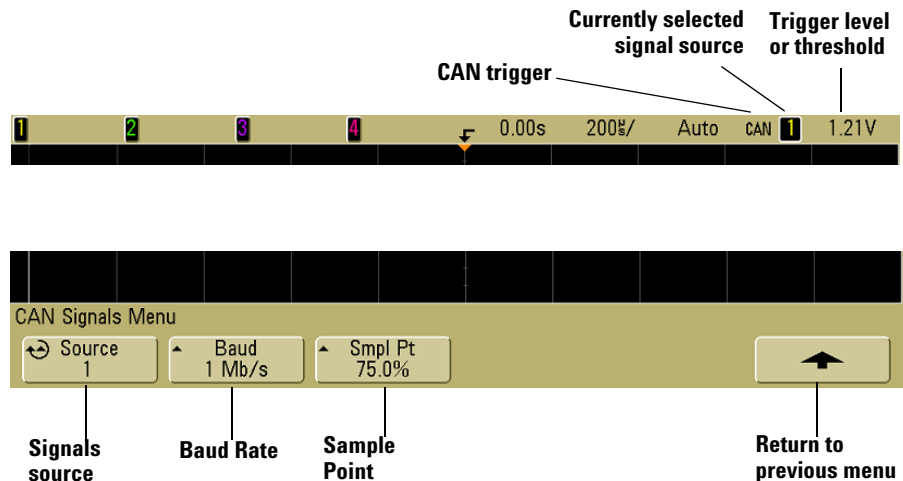

- 4 Press the **Source** softkey to select the channel connected to the CAN signal line.

As you repeatedly press the **Source** softkey (or rotate the Entry knob), the **CAN** label for the source channel is automatically set and the channel you select is shown in the upper-right corner of the display next to “CAN”.

Adjust the trigger level for the selected analog channel by turning the Trigger Level knob. Press the **D15 Thru D0** key and select **Thresholds** to set the threshold level for digital channels. The value of the trigger level or digital threshold is displayed in the upper-right corner of the display.

4 Triggering the Oscilloscope

- 5 Repeatedly press and release the **Baud** softkey to set the CAN signal baud rate to match your CAN bus signal.

The CAN baud rate can be set to:

10 kb/s	50 kb/s	100 kb/s	500 kb/s
20 kb/s	62.5 kb/s	125 kb/s	800 kb/s
33.3 kb/s	83.3 kb/s	250 kb/s	1 Mb/s

The default baud rate is 1 Mb/s

- 6 Repeatedly press and release the **Smpl Pt** softkey to select the point between phase segments 1 and 2 where the state of the bus is measured. This controls the point within the bit's time where the bit value is captured.

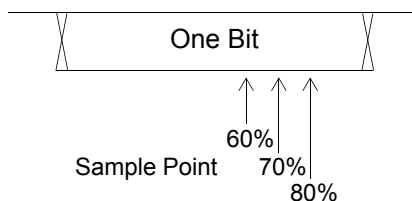

You can use the **Delayed** horizontal sweep mode for easier navigation of the decoded data.

NOTE

If the setup does not produce a stable trigger, the CAN signal may be slow enough that the oscilloscope is AutoTriggering. Press the **Mode/Coupling** key, then press the **Mode** softkey to set the trigger mode from **Auto** to **Normal**.

To use Duration triggering

Duration trigger lets you define a pattern, then trigger on a specified time duration of this logical AND combination of the channels.

- 1 Press the **More** key in the Trigger section of the front panel, rotate the Entry knob until **Duration** is displayed in the **Trigger** softkey, then press the **Settings** softkey to display the Duration trigger menu.

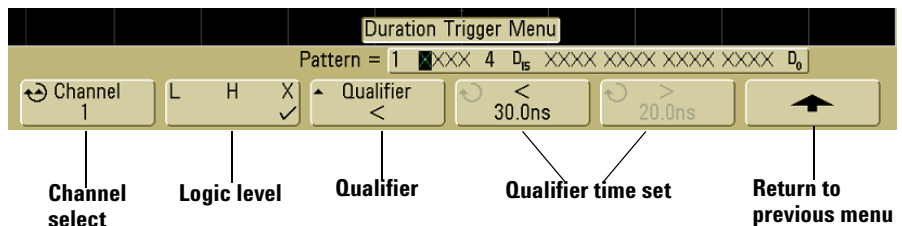

- 2 For each analog or digital channel you want to include in the desired pattern, press the **Channel** softkey to select the channel.

This is the channel source for the H, L, or X condition. As you press the **Channel** softkey (or rotate the Entry knob on mixed-signal oscilloscopes), the channel you select is highlighted in the **Pattern =** line directly above the softkeys and in the upper-right corner of the display next to “**Dur**”. External trigger may also be specified as a channel in the pattern when using the 2-channel and 4-channel oscilloscopes.

Adjust the trigger level for the selected analog channel by turning the Trigger Level knob. Press the **D15 Thru D0** key and select **Thresholds** to set the threshold level for digital channels. The value of the trigger level or digital threshold is displayed in the upper-right corner of the display.

- 3 For each channel you select, press the logic level softkey to set the condition for that channel in the pattern.
 - **H** sets the pattern to high on the selected channel. A high is a voltage level that is greater than the channel's trigger level or threshold level.
 - **L** sets the pattern to low on the selected channel. A low is a voltage level that is less than the channel's trigger level or threshold level.
 - **X** sets the pattern to don't care on the selected channel. Any channel set to don't care is ignored and is not used as part of the pattern. If all channels in the pattern are set to don't care, the oscilloscope will not trigger.
- 4 Press the **Qualifier** softkey to set the time duration qualifier for the pattern.

The time qualifier can set the oscilloscope to trigger on a channel pattern whose time duration is:

- less than a time value (<)
- greater than a time value (>)
- greater than a time value, but with timeout (**Timeout**). A trigger will be forced at the timeout value, rather than occurring when the pattern is exited.
- within a range of time values (><)
- outside a range of time values (<>)

The time values for the selected qualifier are set using the qualifier time set softkeys (< and >) and the Entry knob.

- 5 Select a qualifier time set softkey (< or >), then rotate the Entry knob to set the duration qualifier time.

< qualifier time set softkey

- When the less than (<) qualifier is selected, the Entry knob sets the oscilloscope to trigger on a pattern duration less than the time value displayed on the softkey.
- When the within time range (><) qualifier is selected, the Entry knob sets the upper time range value.
- When the out of time range (<>) qualifier is selected, the Entry knob sets the lower time range value.

> qualifier time set softkey

- When the greater than (>) qualifier is selected, the Entry knob sets the oscilloscope to trigger on a pattern duration greater than the time value displayed on the softkey.
- When the within time range (><) qualifier is selected, the Entry knob sets the lower time range value.
- When the out of time range (<>) qualifier is selected, the Entry knob sets the upper time range value.
- When **Timeout** qualifier is selected, the Entry knob sets the timeout value.

When the duration trigger occurs

The timer starts on the last edge that makes the pattern (logical AND) true. The trigger will occur on the first edge that makes the pattern false if the time qualifier criteria of the pattern has been met, except in Timeout mode. In Timeout, the trigger occurs when the timeout value is reached while the pattern is true.

To use I²C triggering

NOTE

For I²C decode setup see [page 216](#).

An I²C (Inter-IC bus) trigger setup consists of connecting the oscilloscope to the serial data (SDA) line and the serial clock (SCL) line, then triggering on a stop/start condition, a restart, a missing acknowledge, an EEPROM data read, or on a read/write frame with a specific device address and data value.

- 1 Press the **More** key in the Trigger section of the front panel, rotate the Entry knob until **I²C** is displayed in the **Trigger** softkey, then press the **Settings** softkey to display the I²C trigger menu.

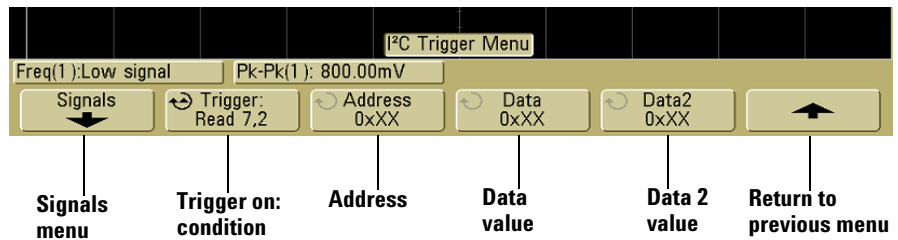
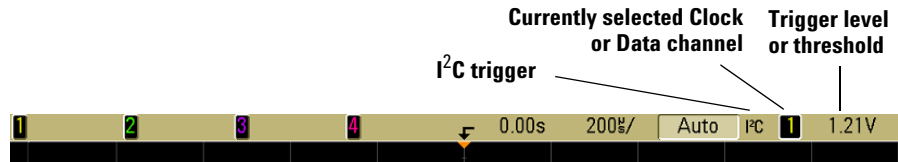

- 2 Press the **Signals** softkey to display the I²C signals menu.

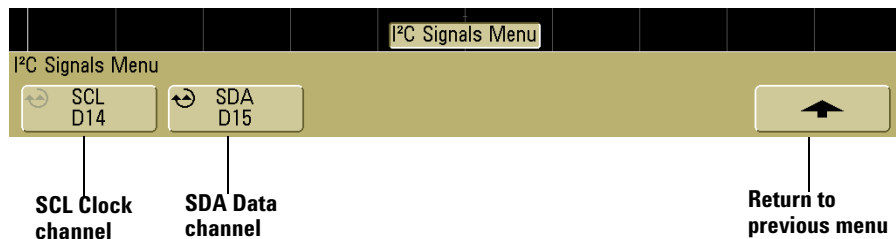

- 3 Connect an oscilloscope channel to the SCL (serial clock) line in the circuit under test, then set the **SCL** clock channel softkey to that channel.

As you press the **SCL** softkey (or rotate the Entry knob on mixed-signal oscilloscopes), the **SCL** label for the source channel is automatically set and the channel you select is shown in the upper-right corner of the display next to “I²C”.

Adjust the trigger level for the selected analog channel by turning the Trigger Level knob. Press the **D15 Thru D0** key and select **Thresholds** to set the threshold level for digital channels. The value of the trigger level or digital threshold is displayed in the upper-right corner of the display.

- 4 Choose 7-bit or 8-bit address size. Use 8-bit address size to include the R/W bit as part of the address value, or choose 7-bit address size to exclude the R/W bit from the address value.
- 5 Connect an oscilloscope channel to the SDA (serial data) line in the circuit under test, then set the **SDA** data channel softkey to that channel.

As you press the **SDA** softkey (or rotate the Entry knob on mixed-signal oscilloscopes), the **SDA** label for the source channel is automatically set and the channel you select is shown in the upper-right corner of the display next to “I²C”.

Adjust the trigger level for the selected analog channel by turning the Trigger Level knob. Press the **D15 Thru D0** key and select **Thresholds** to set the threshold level for digital channels. The value of the trigger level or digital threshold is displayed in the upper-right corner of the display.

4 Triggering the Oscilloscope

Data needs to be stable during the whole high clock cycle or it will be interpreted as a start or stop condition (data transitioning while the clock is high).

6 Return to the previous menu; then, press the **Trigger:** softkey to select one of the following I²C trigger conditions:

- **Start Condition** – The oscilloscope triggers when SDA data transitions from high to low while the SCL clock is high. For triggering purposes (including frame triggers), a restart is treated as a start condition.
- **Stop Condition** – The oscilloscope triggers when data (SDA) transitions from low to high while the clock (SCL) is high.

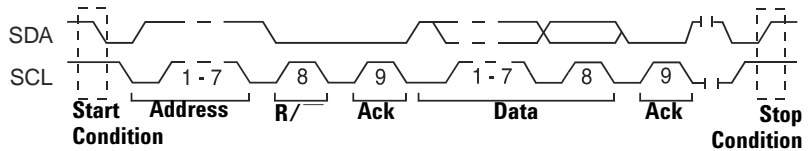

- **Missing Acknowledge** – The oscilloscope triggers when SDA data is high during any Ack SCL clock bit.
- **Address with no Ack** – The oscilloscope triggers when the acknowledge of the selected address field is false. The R/W bit is ignored.
- **Restart** – The oscilloscope triggers when another start condition occurs before a stop condition.

- EEPROM Data Read** – The trigger looks for EEPROM control byte value 1010xxx on the SDA line, followed by a Read bit and an Ack bit. It then looks for the data value and qualifier set by the **Data** softkey and the **Data is** softkey. When this event occurs, the oscilloscope will trigger on the clock edge for the Ack bit after the data byte. This data byte does not need to occur directly after the control byte.

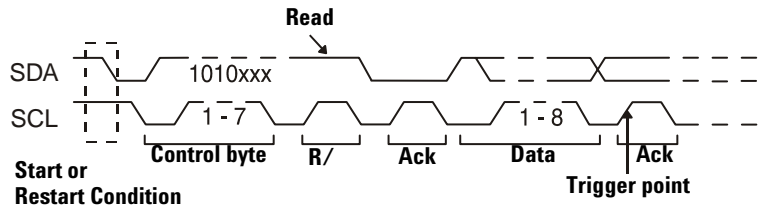

- Frame (Start: Addr7: Read: Ack: Data) or Frame (Start: Addr7: Write: Ack: Data)** – The oscilloscope triggers on a read or write frame in 7-bit addressing mode on the 17th clock edge if all bits in the pattern match. For triggering purposes, a restart is treated as a start condition.

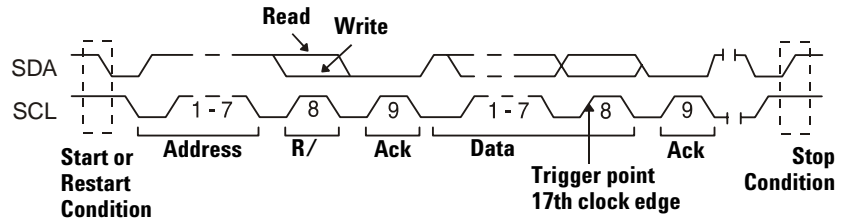

4 Triggering the Oscilloscope

- **Frame (Start: Addr7: Read: Ack: Data: Ack: Data2) or Frame (Start: Addr7: Write: Ack: Data: Ack: Data2)** – The oscilloscope triggers on a read or write frame in 7-bit addressing mode on the 26th clock edge if all bits in the pattern match. For triggering purposes, a restart is treated as a start condition.

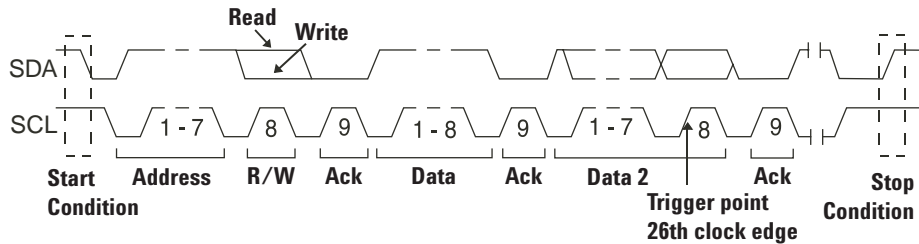

- **10-bit Write** – The oscilloscope triggers on a 10-bit write frame on the 26th clock edge if all bits in the pattern match. The frame is in the format:

Frame (Start: Address byte 1: Write: Address byte 2: Ack: Data)

For triggering purposes, a restart is treated as a start condition.

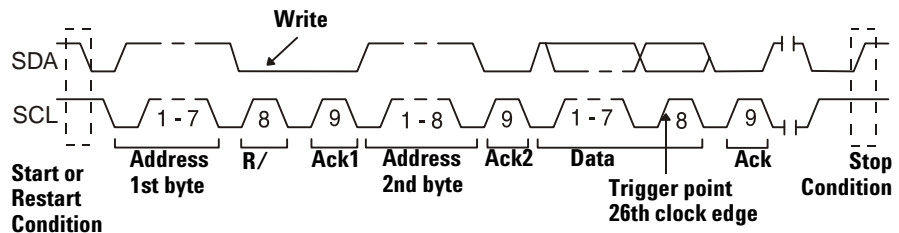

- 7** If you have set the oscilloscope to trigger on an EEPROM Data Read condition:

Press the **Data is** softkey to set the oscilloscope to trigger when data is = (equal to), \neq (not equal to), < (less than), or > (greater than) the data value set in the **Data** softkey.

The oscilloscope will trigger on the clock edge for the Ack bit after the trigger event is found. This data byte does not need to occur directly after the control byte. The oscilloscope will trigger on any data byte that meets the criteria defined by the **Data is** and **Data** softkeys during a current address read or a random read or a sequential read cycle.

- 8 If you have set the oscilloscope to trigger on a 7-bit address read or write frame condition or a 10-bit write frame condition:
 - a Press the **Address** softkey and turn the Entry knob to select the 7-bit or 10-bit device address.

You can select from an address range of 0x00 to 0x7F (7-bit) or 0x3FF (10-bit) hexadecimal. When triggering on a read/write frame, the oscilloscope will trigger after the start, address, read/write, acknowledge, and data events occur.

If don't care is selected (0xXX or 0xXXX) for the address, the address will be ignored. The trigger will always occur on the 17th clock for 7-bit addressing or 26th clock for 10-bit addressing.

- b Press the **Data** value softkey and turn the Entry knob to select the 8-bit data pattern on which to trigger.

You can select a data value in the range of 0x00 to 0xFF (hexadecimal). The oscilloscope will trigger after the start, address, read/write, acknowledge, and data events occur.

If don't care (0xXX) is selected for data, the data will be ignored. The trigger will always occur on the 17th clock for 7-bit addressing or 26th clock for 10-bit addressing.

- c If you have selected a three-byte trigger, press the **Data2** value softkey and turn the Entry knob to select the 8-bit data pattern on which to trigger.

To use Nth Edge Burst triggering

The Nth Edge Burst trigger lets you trigger on the Nth edge of a burst that occurs after an idle time.



Nth Edge Burst trigger set up consists of selecting the source, the slope of the edge, the idle time, and the number of the edge:

- 1 Press the **More** key in the Trigger section of the front panel, rotate the Entry knob until **Nth Edge Burst** is displayed in the **Trigger** softkey.
- 2 Press the **Settings** softkey to display the Nth Edge Burst trigger menu.

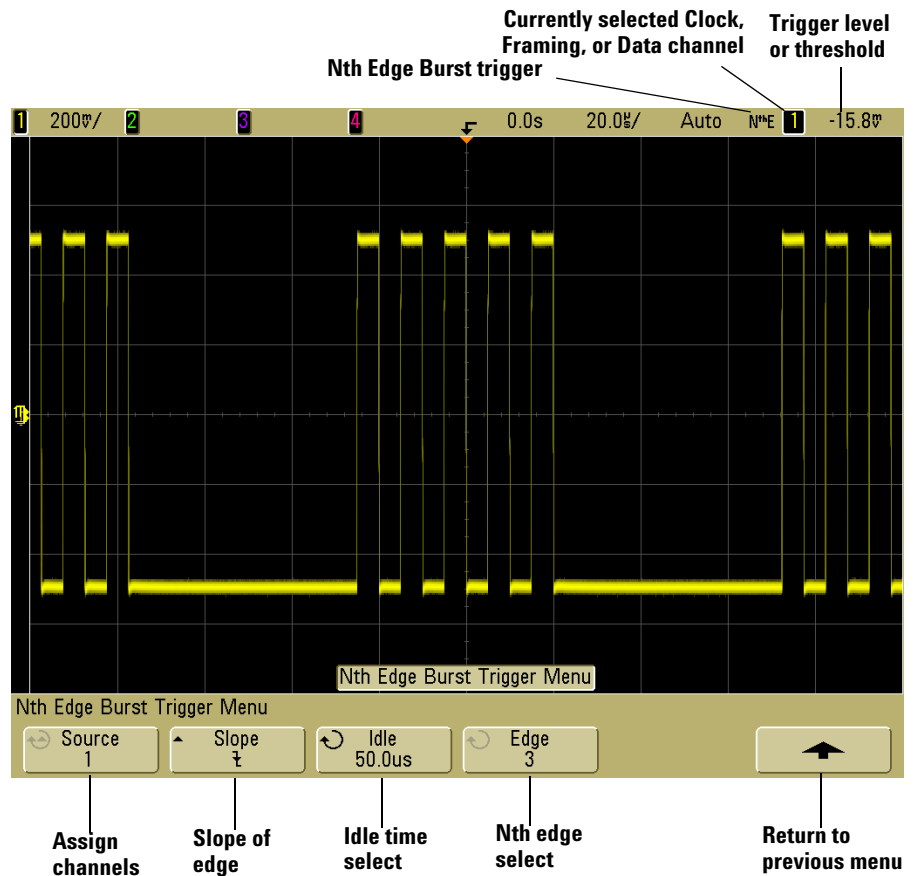

- 3 Press the **Slope** softkey to specify the slope of the edge.
- 4 Press the **Idle** softkey; then, turn the Entry knob to specify the idle time.
- 5 Press the **Edge** softkey; then, turn the Entry knob to which edge to trigger on.

To use LIN triggering

NOTE

For LIN decode information see [page 232](#).

LIN (Local Interconnect Network) trigger setup consists of connecting the oscilloscope to a serial LIN signal.

LIN triggering will trigger on the rising edge at the Sync Break exit of the LIN single-wire bus signal that marks the beginning of the message frame. If the N5424A CAN/LIN Automotive Triggering and Decode option is installed on your oscilloscope, the Frame ID trigger type will also be available.

A LIN signal message frame is shown below:

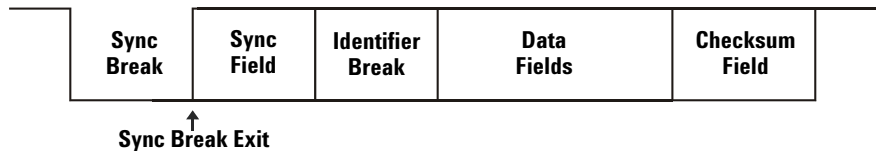

- 1 Press the **More** key in the Trigger section of the front panel, rotate the Entry knob until **LIN** is displayed in the **Trigger** softkey.
- 2 Press the **Settings** softkey to display LIN trigger menu.

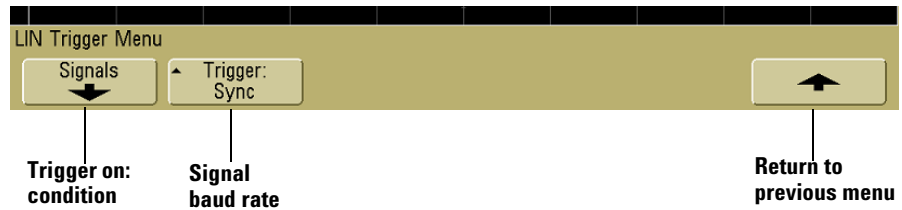
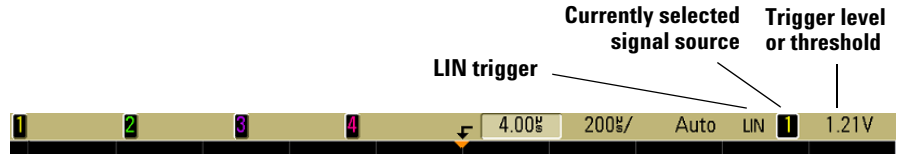

- 3 Press the **Trigger:** softkey and choose to trigger on Sync Break or Frame ID.

Sync (Sync Break) The oscilloscope will trigger on the rising edge at the Sync Break exit of the LIN single-wire bus signal that marks the beginning the message frame.

ID (Frame ID) The oscilloscope will trigger when a frame with an ID equal to the selected value is detected. Use the **Entry** knob to select the value for the Frame ID.

4 Triggering the Oscilloscope

- 4 Press the **Signals** softkey. The LIN Signals Menu will be displayed.

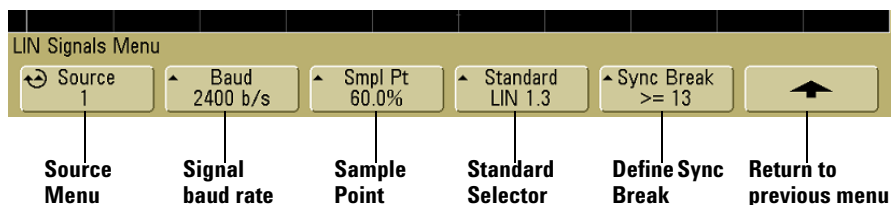

- 5 Press the **Source** softkey to select the channel connected to the LIN signal line.

Adjust the trigger level for the selected analog channel by turning the Trigger Level knob. Press the **D15 Thru D0** key and select **Thresholds** to set the threshold level for digital channels. The value of the trigger level or digital threshold is displayed in the upper-right corner of the display.

- 6 Press the **Baud** softkey to set the LIN signal baud rate to match your LIN bus signal.

The LIN baud rate can be set to 2400 b/s, 9600 b/s, or 19.2 kb/s. The default baud rate is 2400 b/s.

- 7 Press the **Smpl Pt** softkey to select the sample point at which the oscilloscope will sample the bit value.

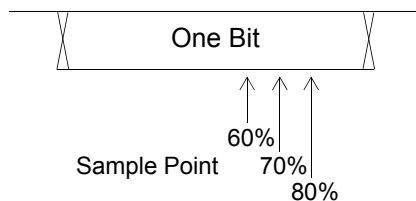

- 8 Press the **Standard** softkey to select the LIN standard you are measuring (LIN 1.3 or LIN 2.0).
- 9 Press the **Sync Break** softkey and select the minimum number of clocks that define a sync break in your LIN signal.

To use Sequence triggering

Sequence trigger lets you trigger the oscilloscope after finding a sequence of events. Defining a sequence trigger requires three steps:

- 1 Define an event to find before you search for the trigger.

The “find” event can be a pattern, an edge from a single channel, or the combination of a pattern and a channel edge.

- 2 Define the trigger event.

The “trigger on” event can be a pattern, an edge from a single channel, the combination of a pattern and a channel edge, or the nth occurrence of an edge from a single channel.

- 3 Set an optional reset event.

If you choose to define a “reset” event, the event can be a pattern, an edge from a single channel, the combination of a pattern and a channel edge, or a timeout value.

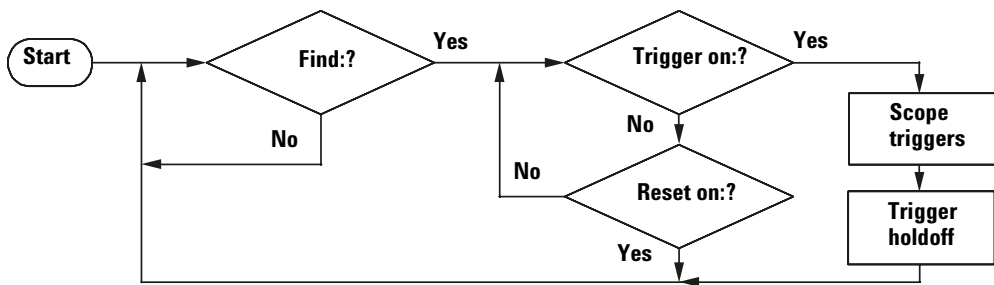

Figure 9 Sequence Trigger Flowchart

To access the sequence trigger settings, press the **More** key in the Trigger section of the front panel, rotate the Entry knob until **Sequence** is displayed in the **Trigger** softkey, then press the **Settings** softkey to display Sequence trigger menu.

4 Triggering the Oscilloscope

Sequence trigger

Selected channel

Trigger level or threshold

Sequence stage definitions

Term definitions

0.0s 5.00% Auto Seq 1 103

Sequence Stages

First, find:
Pattern 1 Entered

Then, trigger on:
Pattern 2 Entered

Reset on:
No Reset

P1: 1	<input checked="" type="checkbox"/>	2	D ₁₅	XXXX	XXXX	XXXX	XXXX	D ₀
P2: 1	<input type="checkbox"/>	2	D ₁₅	XXXX	XXXX	XXXX	XXXX	D ₀
E1: 1	<input type="checkbox"/>	2	D ₁₅	XXXX	XXXX	XXXX	XXXX	D ₀
E2: 1	<input type="checkbox"/>	2	D ₁₅	XXXX	XXXX	XXXX	XXXX	D ₀

N = 1
Timeout = 100ns

Sequence Trigger Menu

Channel 1 Stage Find Find: P1 Enter Term Pattern 1 L H X

Channel select Stage select Find, Trigger on, or Reset condition Select term Define term Return to previous menu

As you set stage, term, and channel definitions for the sequence trigger, these settings will be shown in the waveform area of the display.

Define the Find: stage

- 1 Press the **Stage** softkey and select **Find:**.

Find: is the first stage in the trigger sequence. When you select the **Stage Find** softkey, the next softkey to the right will display **Find:** and give you a list of the terms you can define for the Find stage. The Find stage can be set to one of the following conditions:

- **Pattern 1 Entered** – A pattern is entered on the last edge that makes the pattern true (logical AND).
- **Pattern 1 Exited** – A pattern is exited on the first edge that makes the pattern false (logical NAND).
- **Edge 1**
- **Pattern 1 and Edge 1**

- 2 Press the **Find:** softkey and select the Find stage condition.

- 3 To define the term(s) used in the Find stage, press the **Term** softkey and select the pattern and/or edge term displayed in the **Find:** softkey.

- 4 If you select a pattern term, each channel in the pattern must be set to a **H** (high), **L** (low), or **X** (don't care).

- a Press the **Channel** softkey (or rotate the Entry knob on mixed-signal oscilloscopes) to select the channel.

As you select a channel, the channel is highlighted in the selected pattern list shown in the waveform area and is also shown in the upper-right corner of the display next to “Seq”

- b Press the **L H X** softkey to set a level for the channel.

- **H** sets the pattern to high on the selected channel. A high is a voltage level that is greater than the channel's trigger level or threshold level.
- **L** sets the pattern to low on the selected channel. A low is a voltage level that is less than the channel's trigger level or threshold level.

- **X** sets the pattern to don't care on the selected channel. Any channel set to don't care is ignored and is not used as part of the pattern. If all channels in the pattern are set to don't care, the oscilloscope will not trigger.

Adjust the trigger level for the selected analog channel by turning the Trigger Level knob. Press the **D15 Thru D0** key and select **Thresholds** to set the threshold level for digital channels. The value of the trigger level or digital threshold is displayed in the upper-right corner of the display.

- Repeat for all channels in the pattern.
- If you select an edge term, one channel must be set to a rising edge or a falling edge. All other channel edges will be set to don't care (X).
 - Press the **Channel** softkey (or rotate the Entry knob on mixed-signal oscilloscopes) to select the channel.

As you select a channel, the channel is highlighted in the selected pattern list shown in the waveform area.
 - Then press the **↕ ↘ X** softkey to select rising edge or falling edge. All other channels will be defaulted to don't care (X).

If you want to reassign an edge to a different channel, repeat the above step. The value of the original channel edge will be defaulted to **X** (don't care).

If the term(s) used in the "Find:" Sequence Stage condition are set to "don't care," the oscilloscope will not trigger. At least one term in the stage must be set to a value other than X (don't care).
--

Define the Trigger on: stage

- Press the **Stage** softkey and select **Trigger on:**.

Trigger on: is the next stage in the trigger sequence. When you select the **Stage Trigger on:** softkey, the next softkey to the right will display **Trigger:** and give you a list of the terms you can define for the Trigger on: stage. The Trigger on: stage can be set to one of the following conditions:

- **Pattern 2 Entered** – A pattern is entered on the last edge that makes the pattern true (logical AND).
 - **Pattern 2 Exited** – A pattern is exited on the first edge that makes the pattern false (logical NAND).
 - **Edge 2**
 - **Pattern 2 and Edge 2**
 - **Nth Edge 2**
 - **Nth Edge 2 (no re-find)**
- 2 Press the **Trigger:** softkey and select a stage to trigger on.
 - 3 To define the term(s) used in the Trigger on: stage, press the **Term** softkey and select the pattern or edge term displayed in the **Trigger:** softkey.
 - 4 If you select a pattern term, each channel in the pattern must be set to a **H** (high), **L** (low), or **X** (don't care).
 - a Press the **Channel** softkey (or rotate the Entry knob on mixed-signal oscilloscopes) to select the channel.
 - b Press the **L H X** softkey to set a level for the channel.
 - c Repeat for all channels in the pattern.
 - 5 If you select an edge term, one channel must be set to a rising edge or a falling edge. All other channel edges will be set to don't care (X).
 - a Press the **Channel** softkey (or rotate the Entry knob on mixed-signal oscilloscopes) to select the channel.

The channel you select is shown in the upper-right corner of the display next to “Seq”.
 - b Then press the **↕ ↘ X** softkey to select rising edge or falling edge. All other channel edges will be defaulted to don't care.
 - 6 When you set a Trigger on: condition to trigger on Edge 2, you can also select which occurrence of Edge 2 to trigger on.
 - a Make sure **Nth Edge 2** or **Nth Edge 2 (no re-find)** is selected in the **Trigger:** softkey.

When **Nth Edge 2** is selected, if the Find event occurs again before the Count (N) event is satisfied, Count (N) will be reset to zero.

When **Nth Edge 2 (no re-find)** is selected, if the Find event occurs again before the Count (N) event is satisfied, the Count (N) is not reset to zero.

- b** Press the **Term** softkey and select **Count (N)**.
- c** Press the **N** softkey, then turn the Entry knob to set the number of edges to wait before triggering.

N can be set from 1 to 10,000.

If the term(s) used in the "Trigger on:" Sequence Stage condition are set to "don't care," the oscilloscope will not trigger. At least one term in the stage must be set to a value other than X (don't care).

Define the optional **Reset on: stage**

- 1** Press the **Stage** softkey and select **Reset on:**.

Reset on: is the last stage in the trigger sequence. When you select the **Stage Reset on:** softkey, the next softkey to the right will display **Reset:** and give you a list of the terms you can define for the **Reset on: stage**. The **Reset on: stage** can be set to one of the following conditions:

- **No Reset** – Resets on the find condition.
- **Pattern 1 (or 2) Entered** – A pattern is entered on the last edge that makes the pattern true (logical AND).
- **Pattern 1 (or 2) Exited** – A pattern is exited on the first edge that makes the pattern false (logic NAND).
- **Edge 1 (or 2)**
- **Pattern 1 and Edge 1**
- **Timeout**

Terms that are grayed-out are not valid in the reset stage.

- 2** Press the **Reset:** softkey and select a term to reset on.
- 3** Press the **Term** softkey and select the pattern, edge, or timeout term displayed in the **Reset:** softkey.
- 4** If you select **No Reset**, no reset stage will be defined.

- 5 If you select a pattern term, each channel in the pattern must be set to a **H** (high), **L** (low), or **X** (don't care).
 - a Press the **Channel** softkey (or rotate the Entry knob on mixed-signal oscilloscopes) to select the channel.
 - b Press the **L H X** softkey to set a level for the channel.
 - c Repeat for all channels in the pattern.
- 6 If you select an edge term, one channel must be set to a rising edge or a falling edge. All other channel edges will be set to don't care (X).
 - a Press the **Channel** softkey (or rotate the Entry knob on mixed-signal oscilloscopes) to select the channel.
 - b Then press the **↕ ↘ X** softkey to select rising edge or falling edge. All other channel edges will be defaulted to don't care.
- 7 If you select the **Timeout** term, you will need to set a timeout value.
 - a Press the **Term** softkey and select **Timeout**.
 - b Press the **Timeout** softkey, then turn the Entry knob to set the timeout value.

Timeout can be set from 10 ns to 10 seconds. The timer starts when the Find condition has been met. If the timer is running and another Find condition occurs, the timer will restart from time zero.

Adjust the trigger level

- For analog channels, adjust the trigger level for the selected analog channel by turning the Trigger Level knob.
- To set the threshold level for digital channels, press the **D15 Thru D0** key and select **Thresholds**.

The value of the trigger level or digital threshold is displayed in the upper-right corner of the display.

To use SPI triggering

NOTE

For SPI decode information see [page 220](#).

Serial Peripheral Interface (SPI) trigger setup consists of connecting the oscilloscope to a clock, data, and framing signal. You can then trigger on a data pattern that occurs at the start of a frame. The serial data string can be specified to be from 4 to 32 bits long.

When you press the **Settings** softkey, a graphic will be displayed showing the current state of the frame signal, clock slope, number of data bits, and data bit values. Press the **Signals** softkey in the **Settings** menu to see the current source channels for the clock, data, and frame signals.

- Press the **More** key in the Trigger section of the front panel, rotate the Entry knob until **SPI** is displayed in the **Trigger** softkey, then press the **Settings** softkey to display the SPI trigger menu.

Currently selected Clock, Framing, or Data channel

Trigger level or threshold

SPI trigger

0.000s 200% Auto SPI 3 1.40V

Graphic showing current state of the SPI trigger setup

Data string values

~CS

CLK

DATA

Bit 0 Bit 1 Bit N-1 Bit N

Trigger Point

Data: XXXX XXXX

SPI Trigger Menu

Signals

#Bits 8

Bit 0

L H X

Set all Bits X

Assign channels

data bits in string

Data bit select

Data bit value

Set all data bits to value

Return to previous menu

Assign source channels to the clock, data, and frame signals

- 1 Press the **Signals** softkey to access SPI trigger settings for clock source and slope, data source, and frame type and source.

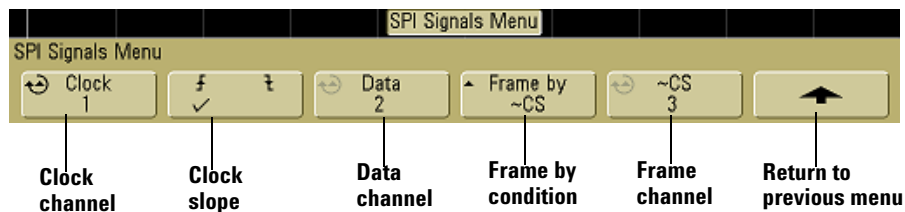

- 2 Press the **Clock** softkey or turn the Entry knob to select the channel connected to the SPI serial clock line.

As you press the **Clock** softkey (or rotate the Entry knob on mixed-signal oscilloscopes), the **CLK** label for the source channel is automatically set and the channel you select is shown in the upper-right corner of the display next to “**SPI**”.

Adjust the trigger level for the selected analog channel by turning the Trigger Level knob. Press the **D15 Thru D0** key and select **Thresholds** to set the threshold level for digital channels. The value of the trigger level or digital threshold is displayed in the upper-right corner of the display.

- 3 Press the slope softkey (\uparrow \downarrow) to select rising edge or falling edge for the selected Clock source.

This determines which clock edge the oscilloscope will use to latch the serial data. When you press the slope softkey, the graphic shown on the display changes to show the current state of the clock signal.

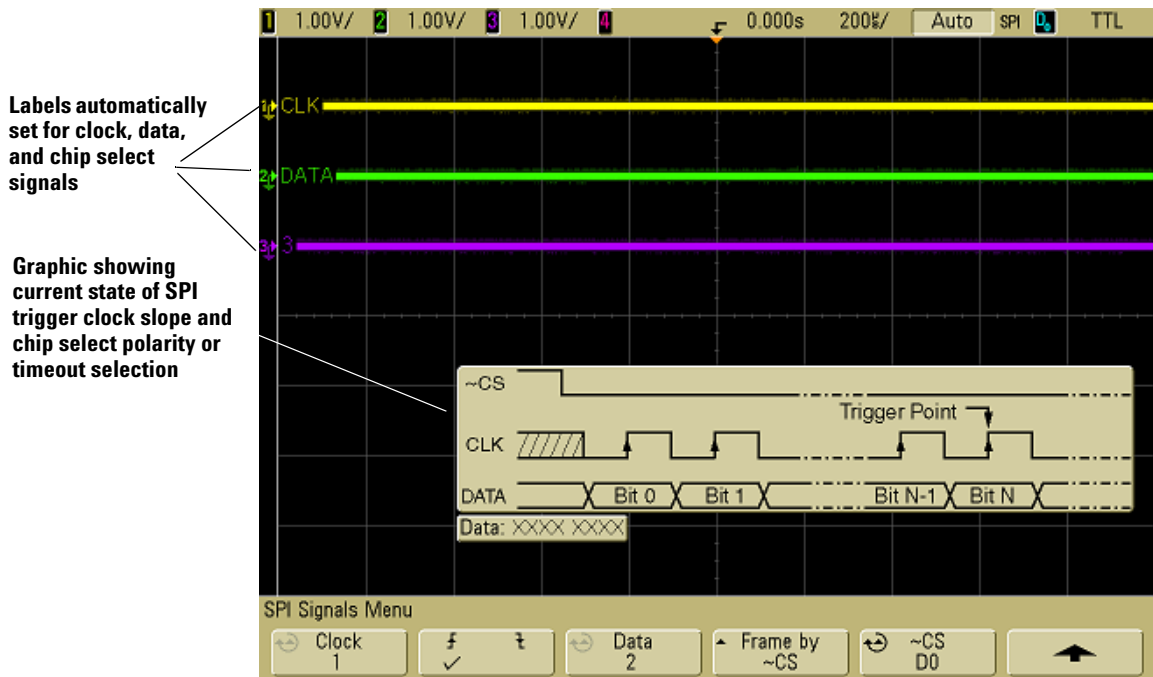

- 4 Press the **Data** softkey or turn the Entry knob to select the channel that is connected to the SPI serial data line. (If the channel you selected is off, switch it on.)

As you press the **Data** softkey (or rotate the Entry knob on mixed-signal oscilloscopes), the **DATA** label for the source channel is automatically set and the channel you select is shown in the upper-right corner of the display next to “**SPI**”.

Adjust the trigger level for the selected analog channel by turning the Trigger Level knob. Press the **D15 Thru D0** key and select **Thresholds** to set the threshold level for digital channels. The value of the trigger level or digital threshold is displayed in the upper-right corner of the display.

- 5 Press the **Frame by** softkey to select a framing signal that the oscilloscope will use for determining which clock edge is the first clock edge in the serial stream.

You can set the oscilloscope to trigger during a high chip select (**CS**), a low chip select (**~CS**), or after a **Timeout** period during which the clock signal has been idle.

- If the framing signal is set to **CS** (or **~CS**), the first clock edge as defined, rising or falling, seen after the **CS** (or **~CS**) signal transitions from low to high (or high to low) is the first clock in the serial stream.

Chip Select – Press the **CS** or **~CS** softkey or turn the Entry knob to select the channel that is connected to the SPI frame line. The label (**~CS** or **CS**) for the source channel is automatically set. The data pattern and the clock transition must occur during the time when the framing signal is valid. The framing signal must be valid for the entire data pattern.

As you press the **CS** or **~CS** softkey (or rotate the Entry knob on mixed-signal oscilloscopes), the **CS** or **~CS** label for the source channel is automatically set and the channel you select is shown in the upper-right corner of the display next to “**SPI**”. When you press the **Frame by** softkey, the graphic shown on the previous page changes to show timeout selection or the current state of the chip select signal.

Adjust the trigger level for the selected analog channel by turning the Trigger Level knob. Press the **D15 Thru D0** key and select **Thresholds** to set the threshold level for digital channels. The value of the trigger level or digital threshold is displayed in the upper-right corner of the display.

- If the framing signal is set to **Timeout**, the oscilloscope generates its own internal framing signal after it sees inactivity on the serial clock line.

Clock Timeout – Select **Clock Timeout** in the **Frame by** softkey, then select the **Timeout** softkey and turn the Entry knob to set the minimum time that the Clock signal must be idle (not transitioning) before the oscilloscope will search for the Data pattern on which to trigger. When you press the **Frame by** softkey, the graphic shown on the previous page changes to show timeout selection or the current state of the chip select signal.

The Timeout value can be set anywhere from 100 ns to 10 s.

- 6 Press the up-arrow softkey to return to the previous menu.

Set up the number of bits in the serial data string and set values for those data bits

- 1 Press the **#Bits** softkey, and turn the Entry knob to set the number of bits (**#Bits**) in the serial data string. The number of bits in the string can be set anywhere from 4 bits to 32 bits. The data values for the serial string are displayed in the Data string in the waveform area.
- 2 Turn the Entry knob to select a specific data bit in the serial string as shown in the **Bit** softkey.

As you rotate the Entry knob, the bit is highlighted in the Data string shown in the waveform area.

- 3 Press the **L H X** softkey to set the bit selected in the **Bit** softkey to **L** (low), **H** (high), or **X** (don't care).

Repeat steps 2 and 3 to assign values for all bits.

Resetting all bits in the serial data string to one value

- To reset all of the bit values in the serial data string to one value (L, H, or X):
 - a Press the **L H X** softkey to select your reset bit value.
 - b Press the **Set all Bits** softkey to reset the data string to the selected value.

To use TV triggering

TV triggering can be used to capture the complicated waveforms of most standard and high-definition analog video signals. The trigger circuitry detects the vertical and horizontal interval of the waveform and produces triggers based on the TV trigger settings you have selected.

4 Triggering the Oscilloscope

The oscilloscope's MegaZoom III technology gives you bright, easily viewed displays of any part of the video waveform. Analysis of video waveforms is simplified by the oscilloscope's ability to trigger on any selected line of the video signal.

- 1 Press the **More** key in the Trigger section of the front panel. If **TV** is not selected, rotate the Entry knob until **TV** is displayed in the **Trigger** softkey, then press the **Settings** softkey to display TV trigger menu.

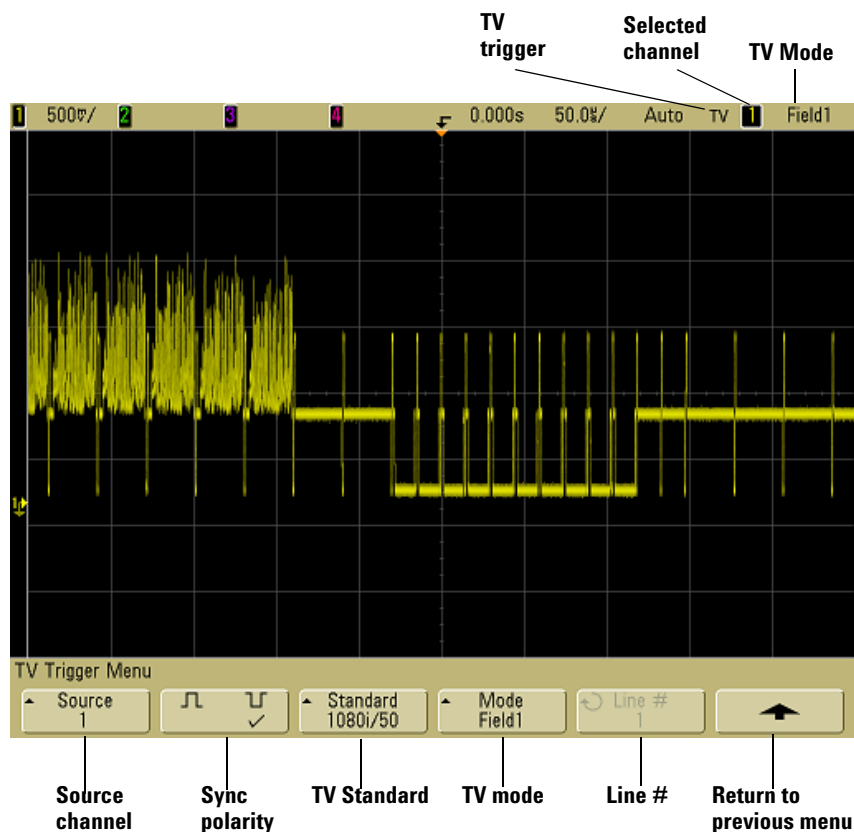

- 2 Press the **Source** softkey and select any analog channel as the TV trigger source.

The selected trigger source is displayed in the upper-right corner of the display. Turning the Trigger **Level** knob does not change the trigger level because the trigger level is automatically set to the sync pulse. Trigger coupling is automatically set to **TV** in the Trigger **Mode/Coupling** menu.

Provide Correct Matching

Many TV signals are produced from 75 Ω sources. To provide correct matching to these sources, a 75 Ω terminator (such as an Agilent 11094B) should be connected to the oscilloscope input.

- 3 Press the sync polarity softkey to set the TV trigger to either positive (\square) or negative (\square) sync polarity.
- 4 Press the **Standard** softkey to set the TV standard.

The oscilloscope supports triggering on the following television (TV) and video standards.

Standard	Type	Sync Pulse
NTSC	Interlaced	Bi-level
PAL	Interlaced	Bi-level
PAL-M	Interlaced	Bi-level
SECAM	Interlaced	Bi-level
Generic	Interlaced/Progressive	Bi-level/Tri-level
EDTV 480p/60	Progressive	Bi-level
HDTV 720p/60	Progressive	Tri-level
HDTV 1080p/24	Progressive	Tri-level
HDTV 1080p/25	Progressive	Tri-level
HDTV 1080i/50	Interlaced	Tri-level
HDTV 1080i/60	Interlaced	Tri-level

- 5 Press the **Mode** softkey to select the portion of the video signal that you would like to trigger on.

The TV trigger modes available are:

- **Field1** and **Field2** – Trigger on the rising edge of the first serration pulse of field 1 or field 2 (interlaced standards only).
- **All Fields** – Trigger on the rising edge of the first pulse in the vertical sync interval (not available in Generic mode).
- **All Lines** – Trigger on all horizontal sync pulses.

4 Triggering the Oscilloscope

- **Line** – Trigger on the selected line # (EDTV and HDTV standards only).
 - **Line: Field1** and **Line:Field2** – Trigger on the selected line # in field 1 or field 2 (interlaced standards only except 1080i).
 - **Line: Alternate** – Alternately trigger on the selected line # in field 1 and field 2 (NTSC, PAL, PAL-M, and SECAM only).
 - **Vertical** – Trigger on the rising edge of the first serration pulse or approximately 70 μ s after the start of vertical sync, whichever occurs first (only available in Generic mode).
 - **Count: Vertical** – Counts falling edges of sync pulses; triggers on the selected count number (only available in Generic mode).
- 6** If you select a line # mode, press the **Line #** softkey, then rotate the Entry knob to select the line number on which you want to trigger.
- 7** When using the Generic standard and you select a line # mode or **Count:Vertical**, press the **Count #** softkey and rotate the Entry knob to select the desired count number.

Listed below are the line (or count) numbers per field for each video standard.

Table 8 Line (or count for Generic) numbers per field for each non-HDTV/EDTV video standard

Video standard	Field 1	Field 2	Alt Field
NTSC	1 to 263	1 to 262	1 to 262
PAL	1 to 313	314 to 625	1 to 312
PAL-M	1 to 263	264 to 525	1 to 262
SECAM	1 to 313	314 to 625	1 to 312
Generic	1 to 1024	1 to 1024	1 to 1024 (vertical)

Line Number Represents Count

In **Generic** mode, the line number represents the number of a count instead of a real line number. This is reflected in the label in the softkey changing from **Line** to **Count**. In the **Mode** softkey selections, **Line:Field 1**, **Line:Field 2** and **Count:Vertical** are used to indicate where the counting starts. For an interlaced video signal, the counting starts from the rising edge of the first vertical serration pulse of Field 1 and/or Field 2. For a non-interlaced video signal, the counting starts after the rising edge of the vertical sync pulse.

Table 9 Line numbers for each EDTV/HDTV video standard

EDTV 480p/60	1 to 525
HDTV 720p/60	1 to 750
HDTV 1080p/24	1 to 1125
HDTV 1080p/25	1 to 1125
HDTV 1080i/50	1 to 1125
HDTV 1080i/60	1 to 1125

Example exercises

The following are exercises to familiarize you with TV triggering. These exercises use the NTSC video standard.

To trigger on a specific line of video

TV triggering requires greater than 1/2 division of sync amplitude with any analog channel as the trigger source. Turning the trigger **Level** knob in TV trigger does not change the trigger level because the trigger level is automatically set to the sync pulse tips.

4 Triggering the Oscilloscope

One example of triggering on a specific line of video is looking at the vertical interval test signals (VITS), which are typically in line 18. Another example is closed captioning, which is typically in line 21.

- 1 Press the Trigger **More** key, then press the **TV** softkey.
- 2 Press the **Settings** softkey, then press the **Standard** softkey to select the appropriate TV standard (NTSC).
- 3 Press the **Mode** softkey and select the TV field of the line you want to trigger on. You can choose **Line:Field1**, **Line:Field2**, or **Line:Alternate**.
- 4 Press the **Line #** softkey and select the number of the line you want to examine.

Alternate Triggering

If **Line:Alternate** is selected, the oscilloscope will alternately trigger on the selected line number in Field 1 and Field 2. This is a quick way to compare the Field 1 VITS and Field 2 VITS or to check for the correct insertion of the half line at the end of Field 1.

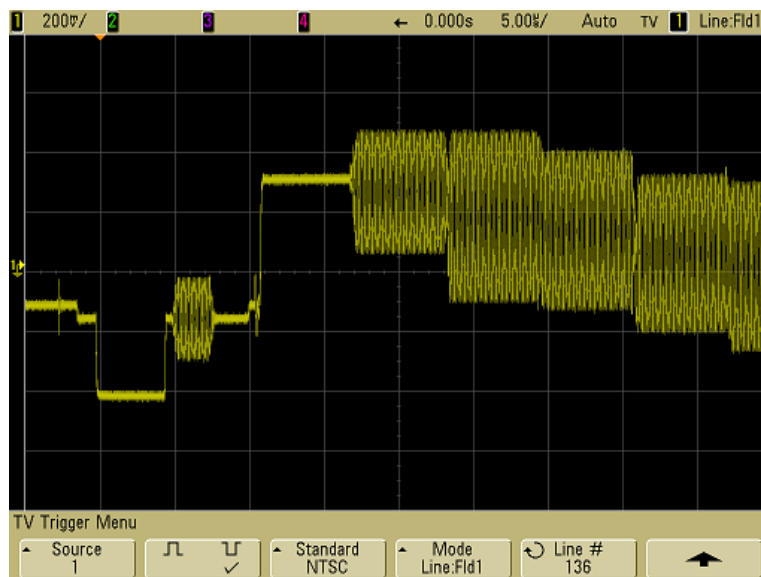

Figure 10 Example: Triggering on Line 136

To trigger on all sync pulses

To quickly find maximum video levels, you could trigger on all sync pulses. When **All Lines** is selected as the TV trigger mode, the oscilloscope will trigger on all horizontal sync pulses.

- 1 Press the Trigger **More** key, then press the **TV** softkey.
- 2 Press the **Settings** softkey, then press the **Standard** softkey to select the appropriate TV standard.
- 3 Press the **Mode** softkey and select **All Lines**.

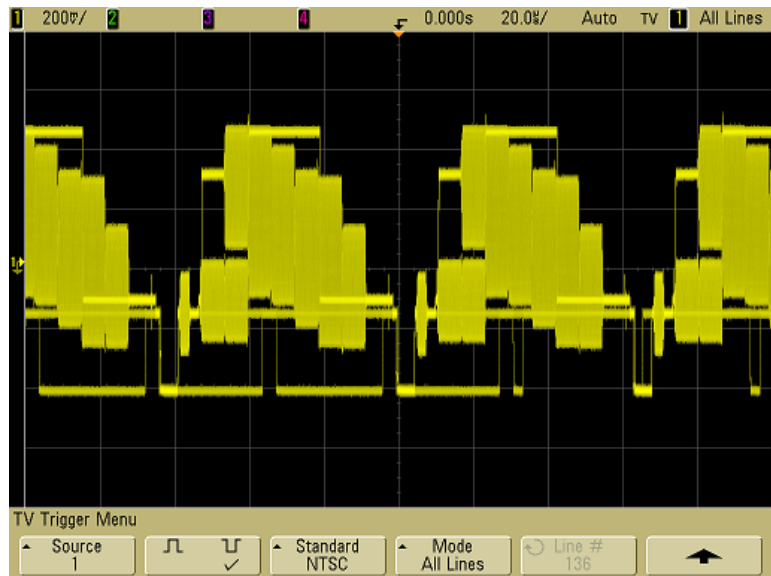

Figure 11 Triggering on All Lines

To trigger on a specific field of the video signal

To examine the components of a video signal, trigger on either Field 1 or Field 2 (available for interleaved standards). When a specific field is selected, the oscilloscope triggers on the rising edge of the first serration pulse in the vertical sync interval in the specified field (1 or 2).

- 1 Press the Trigger **More** key, then press the **TV** softkey.
- 2 Press the **Settings** softkey, then press the **Standard** softkey to select the appropriate TV standard.
- 3 Press the **Mode** softkey and select **Field1** or **Field2**.

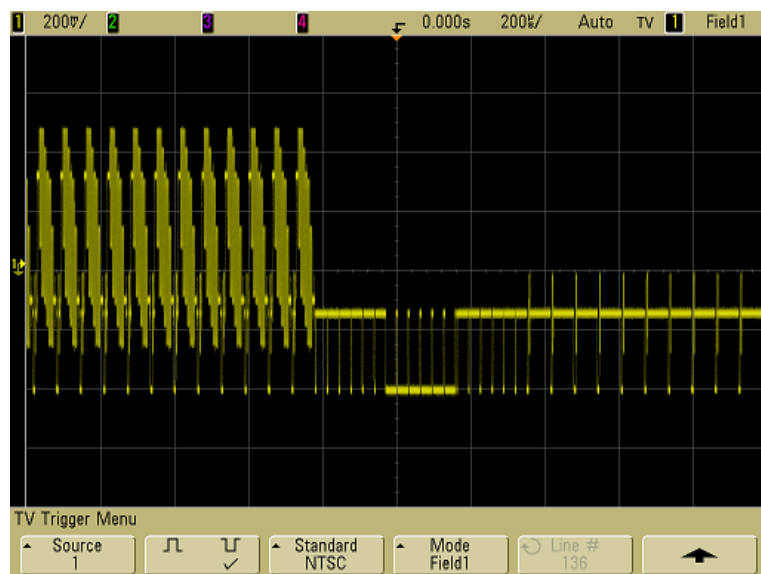

Figure 12 Triggering on Field 1

To trigger on all fields of the video signal

To quickly and easily view transitions between fields, or to find the amplitude differences between the fields, use the All Fields trigger mode.

- 1 Press the Trigger **More** key, then press the **TV** softkey.
- 2 Press the **Settings** softkey, then press the **Standard** softkey to select the appropriate TV standard.
- 3 Press the **Mode** softkey and select **All Fields**.

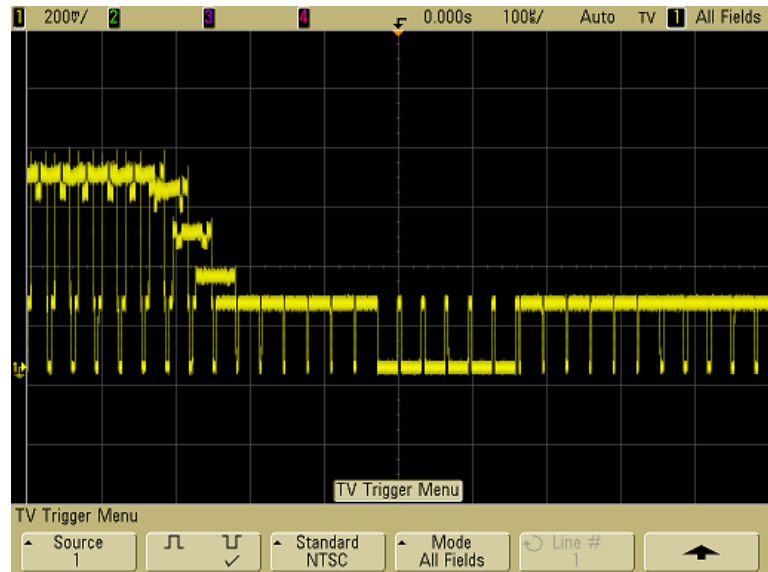

Figure 13 Triggering on All Fields

To trigger on odd or even fields

To check the envelope of your video signals, or to measure worst case distortion, trigger on the odd or even fields. When Field 1 is selected, the oscilloscope triggers on color fields 1 or 3. When Field 2 is selected, the oscilloscope triggers on color fields 2 or 4.

- 1 Press the Trigger **More** key, then press the **TV** softkey.
- 2 Press the **Settings** softkey, then press the **Standard** softkey to select the appropriate TV standard.
- 3 Press the **Mode** softkey and select **Field1** or **Field2**.

The trigger circuits look for the position of the start of Vertical Sync to determine the field. But this definition of field does not take into consideration the phase of the reference subcarrier. When Field 1 is selected, the trigger system will find any field where the vertical sync starts on Line 4. In the case of NTSC video, the oscilloscope will trigger on color field 1 alternating with color field 3 (see the following figure). This setup can be used to measure the envelope of the reference burst.

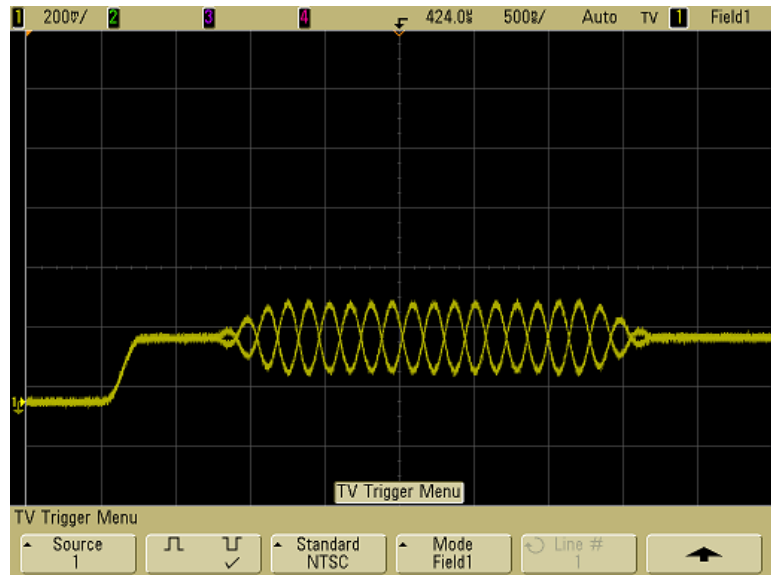

Figure 14 Triggering on Color Field 1 Alternating with Color Field 3

If a more detailed analysis is required, then only one color field should be selected to be the trigger. You can do this by using the **TV Holdoff** softkey in the trigger More Trigger Menu when the trigger type is set to **TV**. Press the **TV Holdoff** softkey and use the Entry knob to adjust the holdoff in half-field increments until the oscilloscope triggers on only one phase of the color burst.

A quick way to synchronize to the other phase is to briefly disconnect the signal and then reconnect it. Repeat until the correct phase is displayed.

When holdoff is adjusted using the **TV Holdoff** softkey and the Entry knob, the corresponding holdoff time will be displayed in the **Mode/Coupling** menu.

4 Triggering the Oscilloscope

Table 10 Half-field holdoff time

Standard	Time
NTSC	8.35 ms
PAL	10 ms
PAL-M	10 ms
SECAM	10 ms
Generic	8.35 ms
EDTV 480p/60	8.35 ms
HDTV 720p/60	8.35 ms
HDTV 1080p/24	20.835 ms
HDTV 1080p/25	20 ms
HDTV 1080i/50	10 ms
HDTV 1080i/60	8.35 ms

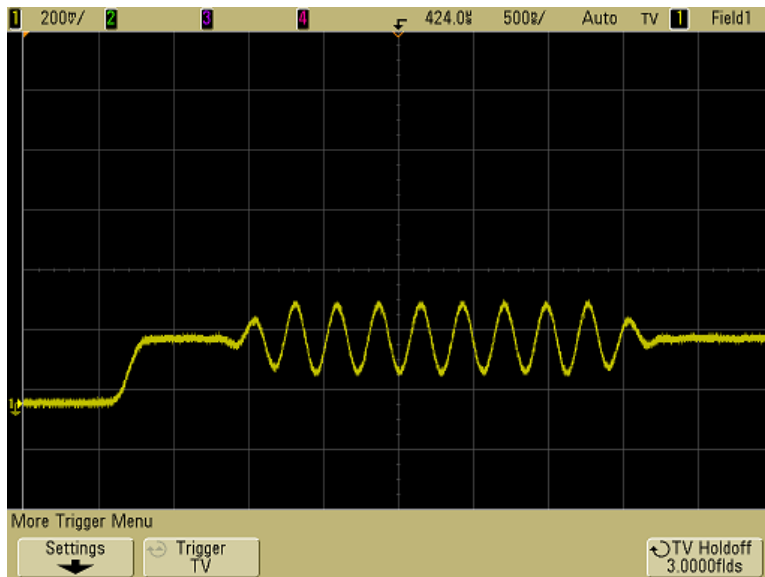
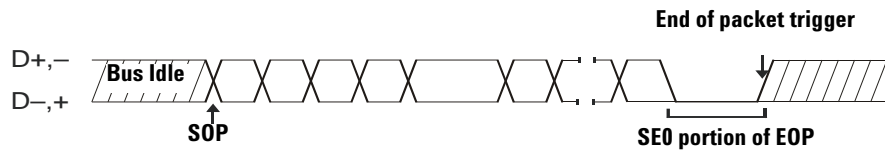

Figure 15 Using TV Holdoff to Synchronize to Color Field 1 or 3 (Field 1 mode)

To use USB triggering

USB trigger will trigger on a Start of Packet (SOP), End of Packet (EOP) signal, Reset Complete (RC), Enter Suspend (Suspend), or Exit Suspend (Exit Sus) on the differential USB data lines (D+ and D-). USB Low Speed and Full Speed are supported by this trigger.



- 1 Press the **More** key in the Trigger section of the front panel, rotate the Entry knob until **USB** is displayed in the **Trigger** softkey, then press the **Settings** softkey to display USB trigger menu.

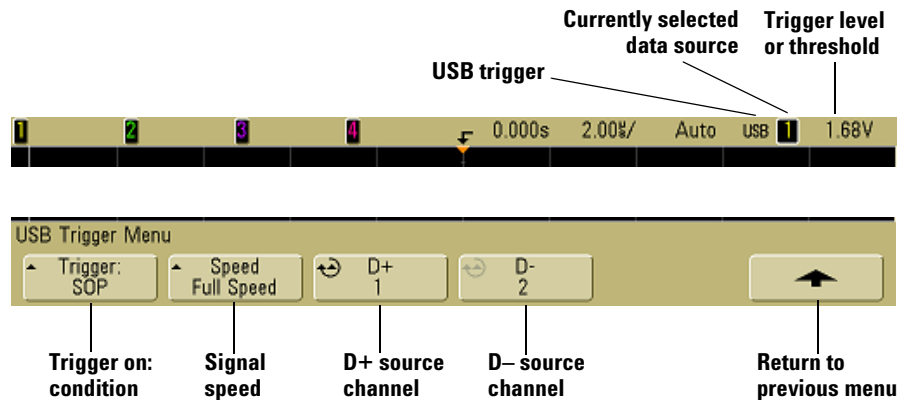

- 2 Press the **Speed** softkey to select the speed of the transaction being probed.

You may select Low Speed (1.5 Mb/s) or Full Speed (12 Mb/s).

- 3 Press the **D+** and **D-** softkeys to select the channel connected to the USB signal D+ and D- lines. The **D+** and **D-** labels for the source channels are automatically set.

4 Triggering the Oscilloscope

As you press the **D+** or **D-** softkey (or rotate the Entry knob on mixed-signal oscilloscopes), the **D+** and **D-** label for the source channel is automatically set and the channel you select is shown in the upper-right corner of the display next to “USB”.

Adjust the trigger level for the selected analog channel by turning the Trigger Level knob. Press the **D15 Thru D0** key and select **Thresholds** to set the threshold level for digital channels. The value of the trigger level or digital threshold is displayed in the upper-right corner of the display.

- 4 Press the **Trigger:** softkey to select where the USB trigger will occur:
- **SOP** (Start of Packet) – triggers at the Sync bit at the beginning of the packet.
 - **EOP** (End of Packet) – triggers at the end of the SE0 portion of the EOP.
 - **RC** (Reset Complete) – triggers when SE0 is > 10 ms.
 - **Suspend** (Enter Suspend) – triggers when the bus is idle > 3 ms.
 - **Exit Sus** (Exit Suspend) – triggers when exiting an idle state > 10 ms. This is used to see the suspend/resume transition.

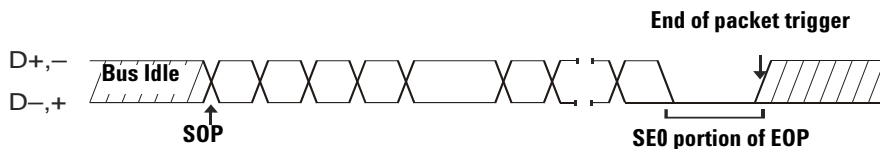

The Trigger Out connector

You can select one of the following signals to be output at the TRIG OUT connector on the rear panel of the oscilloscope:

- Triggers
- Source frequency
- Source frequency/8 (except 100 MHz BW models)

Triggers

This is the default selection. In this mode, a rising edge is output each time the oscilloscope triggers. This rising edge is delayed 17 ns from the oscilloscope's trigger point. The output level is 0-5 V into an open circuit, and 0-2.5 V into 50 Ω

Source frequency

This mode is only available when the oscilloscope is set to edge trigger on a front-panel source (analog channel or the external input of a 2-channel oscilloscope). In this mode, the TRIG OUT BNC is connected to the output of the trigger comparator. The output level is 0-580 mV into an open circuit, and 0-290 mV into 50 Ω . The maximum frequency output is 350 MHz due to the bandwidth limitation of the TRIG OUT BNC amplifier. This selection is useful for driving an external frequency counter.

Source frequency/8

This selection produces the same signal as described in Source frequency except the output frequency is one-eighth of the trigger comparator output frequency. This mode is useful when your input signal is faster than 350 MHz. This selection is not available on 100 MHz bandwidth model oscilloscopes.

The Trigger Out connector also provides the User Cal signal. See “User Calibration” on page 69.

4 Triggering the Oscilloscope



5 Making Measurements

To use the XY horizontal mode [154](#)

Math Functions [159](#)

Cursor Measurements [176](#)

Automatic Measurements [182](#)

Post Acquisition Processing

In addition to changing display parameters after the acquisition, you can perform all of the measurements and math functions after the acquisition. Measurements and math functions will be recalculated as you pan and zoom and turn channels on and off. As you zoom in and out on a signal using the horizontal sweep speed knob and vertical volts/division knob, you affect the resolution of the display. Because measurements and math functions are performed on displayed data, you affect the resolution of functions and measurements.



To use the XY horizontal mode

The XY horizontal mode converts the oscilloscope from a volts-versus-time display to a volts-versus-volts display using two input channels. Channel 1 is the X-axis input, channel 2 is the Y-axis input. You can use various transducers so the display could show strain versus displacement, flow versus pressure, volts versus current, or voltage versus frequency. This exercise shows a common use of the XY display mode by measuring the phase difference between two signals of the same frequency with the Lissajous method.

- 1 Connect a sine wave signal to channel 1, and a sine wave signal of the same frequency but out of phase to channel 2.
- 2 Press the **Autoscale** key, press the **Main/Delayed** key, then press the **XY** softkey.
- 3 Center the signal on the display with the channel 1 and 2 position (\blacklozenge) knobs. Use the channel 1 and 2 volts/div knobs and the channel 1 and 2 **Vernier** softkeys to expand the signal for convenient viewing.

The phase difference angle (θ) can be calculated using the following formula (assuming the amplitude is the same on both channels):

$$\sin\theta = \frac{A}{B} \text{ or } \frac{C}{D}$$

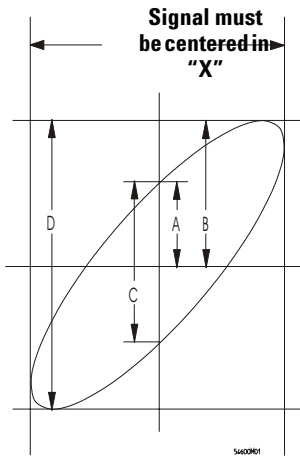

Figure 16 Example of centering a signal on the display



Figure 17 Signal centered on the display

- 4 Press the **Cursors** key.
- 5 Set the Y2 cursor to the top of the signal, and set Y1 to the bottom of the signal.

Note the ΔY value at the bottom of the display. In this example, we are using the Y cursors, but you could have used the X cursors instead.

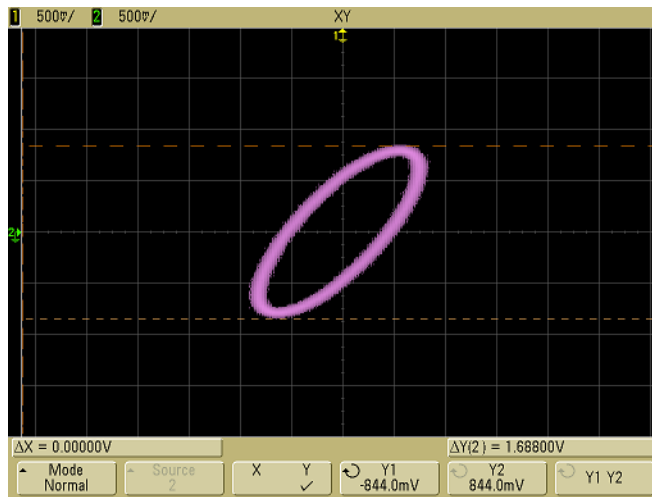

Figure 18 Cursors set on displayed signal

6 Move the Y1 and Y2 cursors to the intersection of the signal and the Y axis.

Again, note the ΔY value.

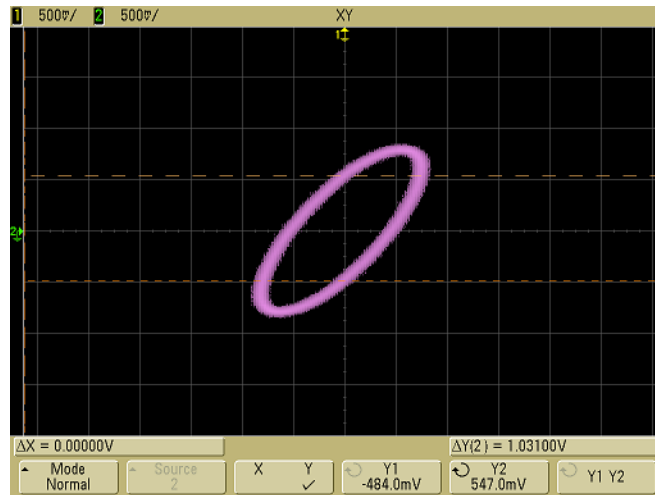

Figure 19 Cursors set to center of signal

7 Calculate the phase difference using the formula below.

$$\sin \theta = \frac{\text{second } \Delta Y}{\text{first } \Delta Y} = \frac{1.031}{1.688} ; \theta = 37.65 \text{ degrees of phase shift}$$

Z-Axis Input in XY Display Mode (Blanking)

When you select the XY display mode, the time base is turned off. Channel 1 is the X-axis input, channel 2 is the Y-axis input, and channel 4 (or the External trigger on 2-channel models) is the Z-axis input. If you only want to see portions of the Y versus X display, use the Z-axis input. Z-axis turns the trace on and off (analog oscilloscopes called this Z-axis blanking because it turned the beam on and off). When Z is low (<1.4 V), Y versus X is displayed; when Z is high (>1.4 V), the trace is turned off.

5 Making Measurements

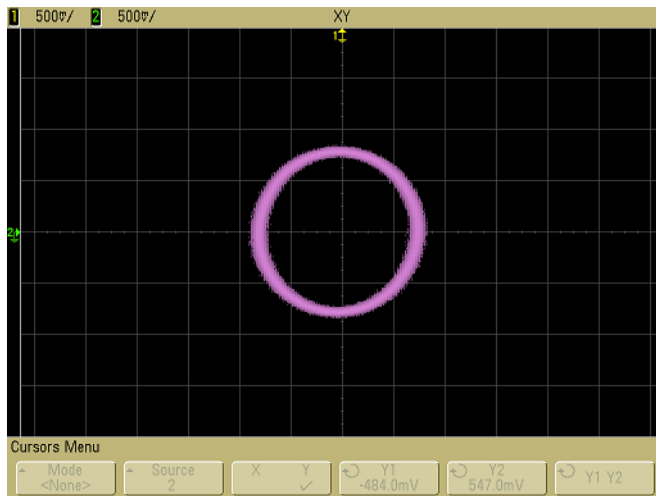

Figure 20 Signals are 90 out of phase

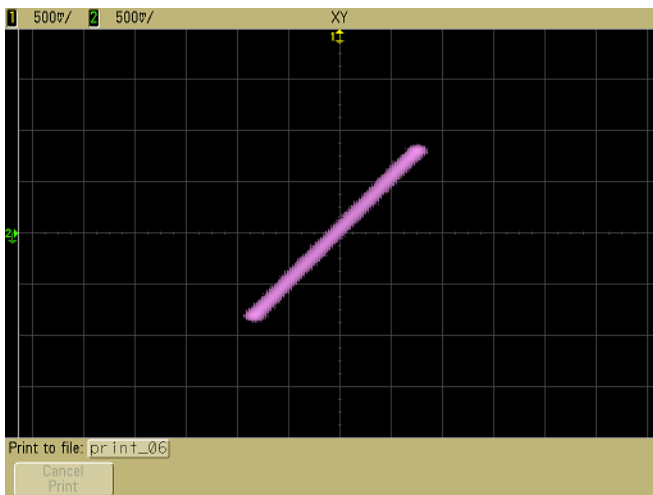

Figure 21 Signals are in phase

Math Functions

The Math menu lets you display math functions on analog channels. You can:

- subtract (–) or multiply (*) the signals acquired on analog channels 1 and 2, then display the result.
- integrate, differentiate, or perform an FFT on the signal acquired on any analog channel or on math functions $1 * 2$, $1 - 2$, or $1 + 2$, then display the result.

To access math functions:

- 1 Press the **Math** key on the front panel to display the Math menu. After selecting a math function, press the **Settings** softkey to display settings for the selected math function if you want to change the Y scaling.

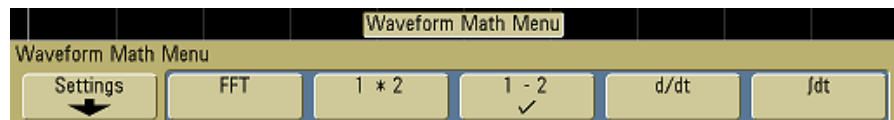

Math Operating Hints

If the analog channel or math function is clipped (not fully displayed on screen,) the resulting displayed math function will also be clipped.

Once the function is displayed, the analog channel(s) may be turned off for better viewing.

The vertical scaling and offset of each math function can be adjusted for ease of viewing and measurement considerations.

Each function can be measured in the Cursors and Quick Meas menus.

Math scale and offset

Any math function may be manually scaled by pressing the **Settings** softkey, and then adjusting the Scale or Offset value.

Math Scale and Offset are Set Automatically

Any time the currently displayed math function definition is changed, the function is automatically scaled for optimum vertical scale and offset. If you manually set scale and offset for a function, select a new function, then select the original function, the original function will be automatically rescaled.

- 1 Press the **Settings** softkey in the Math menu to set your own scale factors (units/division) or offset (units) for the selected math function.

Units for each input channel can be set to Volts or Amps using the channel **Probe Units** softkey. Scale and offset units are:

Math function	Units
FFT	dB* (decibels)
1*2	V ² , A ² , or W (Volt-Amp)
1-2	V or A
d/dt	V/s or A/s (V/second or A/second)
$\int dt$	Vs or As (V-seconds or A-seconds)

* When the FFT source is channel 1, 2, 3 or 4, FFT units will be displayed in dBV when channel units is set to Volts and channel impedance is set to 1 M Ω FFT units will be displayed in dBm when channel units is set to Volts and channel impedance is set to 50 Ω FFT units will be displayed as dB for all other FFT sources or when a source channel's units has been set to Amps.

A scale unit of **U** (undefined) will be displayed for math function 1-2 and for d/dt, and $\int dt$ when 1-2 or 1+2 is the selected source if channel 1 and channel 2 are set to dissimilar units in the channel **Probe Units** softkey.

- 2 Press the **Scale** or **Offset** softkey, then turn the Entry knob to rescale or change the offset value for your math function.

Multiply

When you select **1 * 2**, channel 1 and channel 2 voltage values are multiplied point by point, and the result is displayed. **1 * 2** is useful for seeing power relationships when one of the channels is proportional to the current.

- 1 Press the **Math** key, press the **1 * 2** softkey, then press the **Settings** softkey if you want to change the scaling or offset for the multiply function.
 - **Scale** – lets you set your own vertical scale factors for multiply expressed as V^2/div (Volts-squared/division), A^2/div (Amps-squared/division), or W/div (Watts/division or Volt-Amps/division). Units are set in the channel **Probe** menu. Press the **Scale** softkey, then turn the Entry knob to rescale **1 * 2**.
 - **Offset** – lets you set your own offset for the multiply math function. The offset value is in V^2 (Volts-squared), A^2 (Amps-squared), or W (Watts) and is represented by the center horizontal grid line of the display. Press the **Offset** softkey, then turn the Entry knob to change the offset for **1 * 2**.

The figure below shows an example of multiply.

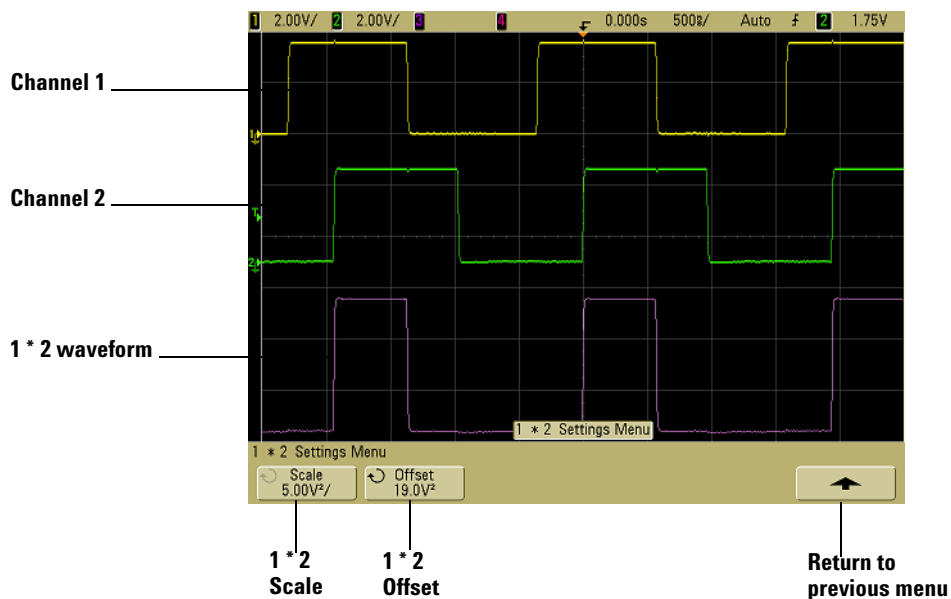

Figure 22 Multiply

Subtract

When you select **1 – 2**, channel 2 voltage values are subtracted from channel 1 voltage values point by point, and the result is displayed.

You can use **1 – 2** to make a differential measurement or to compare two waveforms. You may need to use a true differential probe if your waveforms have DC offsets larger than the dynamic range of the oscilloscope's input channel.

To perform the addition of channel 1 and channel 2, select **Invert** in the Channel 2 menu and perform the **1 – 2** math function.

1 Press the **Math** key, press the **1 – 2** softkey, then press the **Settings** softkey if you want to change the scaling or offset for the subtract function.

- **Scale** – lets you set your own vertical scale factors for subtract, expressed as V/div (Volts/division) or A/div (Amps/division). Units are set in the channel **Probe** menu. Press the **Scale** softkey, then turn the Entry knob to rescale **1 – 2**.
- **Offset** – lets you set your own offset for the **1 – 2** math function. The offset value is in Volts or Amps and is represented by the center horizontal grid line of the display. Press the **Offset** softkey, then turn the Entry knob to change the offset for **1 – 2**.

A scale unit of **U** (undefined) will be displayed for scale and offset if channel 1 and channel 2 are set to dissimilar units in the channel **Probe Units** softkey.

The figure below shows an example of subtract.

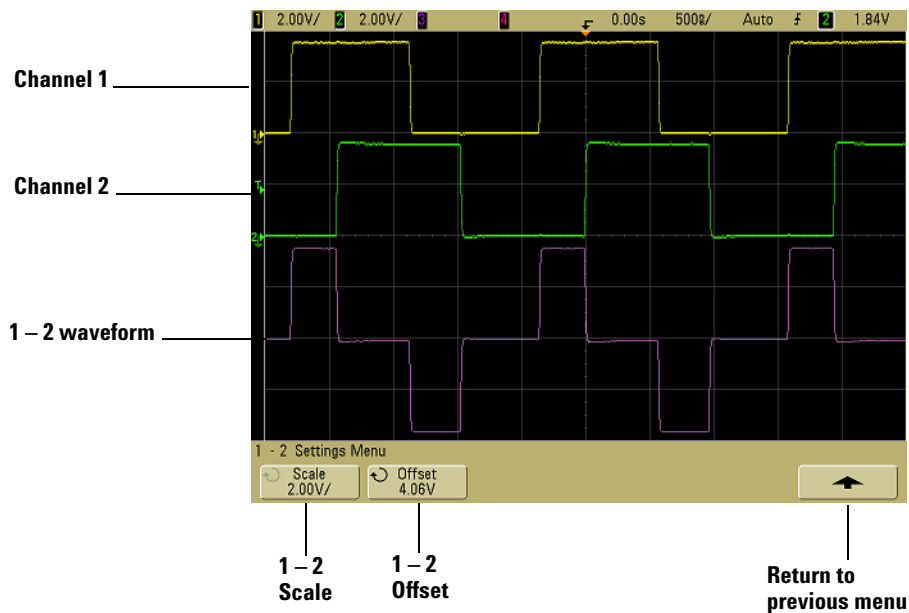

Figure 23 Subtract

Differentiate

d/dt (differentiate) calculates the discrete time derivative of the selected source. You can use differentiate to measure the instantaneous slope of a waveform. For example, the slew rate of an operational amplifier may be measured using the differentiate function.

Because differentiation is very sensitive to noise, it is helpful to set acquisition mode to **Averaging** in the **Acquire** menu.

d/dt plots the derivative of the selected source using the “average slope estimate at 4 points” formula. The equation is:

$$d_i = \frac{y_{i+4} + 2y_{i+2} - 2y_{i-2} - y_{i-4}}{8\Delta t}$$

Where

d = differential waveform

y = channel 1, 2, or function 1 + 2, 1 - 2, and 1 * 2 data points

i = data point index

Δt = point-to-point time difference

In Delayed sweep horizontal mode, the d/ dt function does not display in the delayed portion of the display.

- 1 Press the **Math** key, press the **d/dt** softkey, then press the **Settings** softkey if you want to change the source, scaling, or offset for the differentiate function.
 - **Source** – selects the source for d/dt. The source can be any analog channel, or math functions 1 + 2, 1 - 2, and 1 * 2.
 - **Scale** – lets you set your own vertical scale factors for d/dt expressed in units/second/division, where units can be V (Volts), A (Amps), or W (Watts). Units are set in the channel **Probe** menu. Press the **Scale** softkey, then turn the Entry knob to rescale d/dt.

- **Offset** —lets you set your own offset for the dV/dt math function. The offset value is in units/second where units can be V (Volts), A (Amps), or W (Watts) and is represented by the center horizontal grid line of the display. Press the **Offset** softkey, then turn the Entry knob to change the offset for d/dt .

A scale unit of **U** (undefined) will be displayed for scale and offset when 1-2 or 1+2 is the selected source if channel 1 and channel 2 are set to dissimilar units in the channel **Probe Units** softkey.

The figure below shows an example of differentiate.

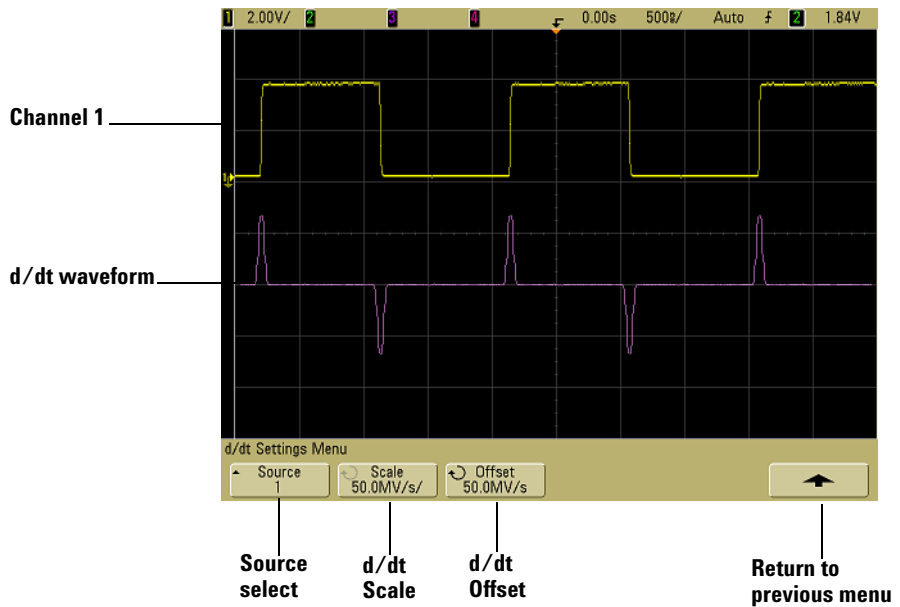

Figure 24 Differentiate

Integrate

$\int dt$ (integrate) calculates the integral of the selected source. You can use integrate to calculate the energy of a pulse in volt-seconds or measure the area under a waveform.

$\int dt$ plots the integral of the source using the “Trapezoidal Rule”. The equation is:

$$I_n = c_0 + \Delta t \sum_{i=0}^n y_i$$

Where

I = integrated waveform

Δt = point-to-point time difference

y = channel 1, 2, or function 1 + 2, 1 - 2, and 1 * 2 data points

c_0 = arbitrary constant

i = data point index

In Delayed sweep horizontal mode, the $\int dt$ function does not display in the delayed portion of the display.

- 1 Press the **Math** key, press the $\int dt$ softkey, then press the **Settings** softkey if you want to change the source, scaling, or offset for the integrate function.
 - **Source** – selects the source for $\int dt$. The source can be any analog channel, or math functions 1 + 2, 1 - 2, and 1 * 2.
 - **Scale** – lets you set your own vertical scale factors for $\int dt$ expressed in unit-seconds/division, where units can be V (Volts), A (Amps), or W (Watts). Units are set in the channel **Probe** menu. Press the **Scale** softkey, then turn the Entry knob to rescale $\int dt$.
 - **Offset** – lets you set your own offset for the $\int Vdt$ math function. The offset value is in unit-seconds where units can be V (Volts), A (Amps), or W (Watts) and is represented by the center horizontal grid line of the display. Press the **Offset** softkey, then turn the Entry knob to change the offset for $\int dt$. The integrate calculation is relative to the source signal’s offset. The following examples illustrate the effects of signal offset.

5 Making Measurements

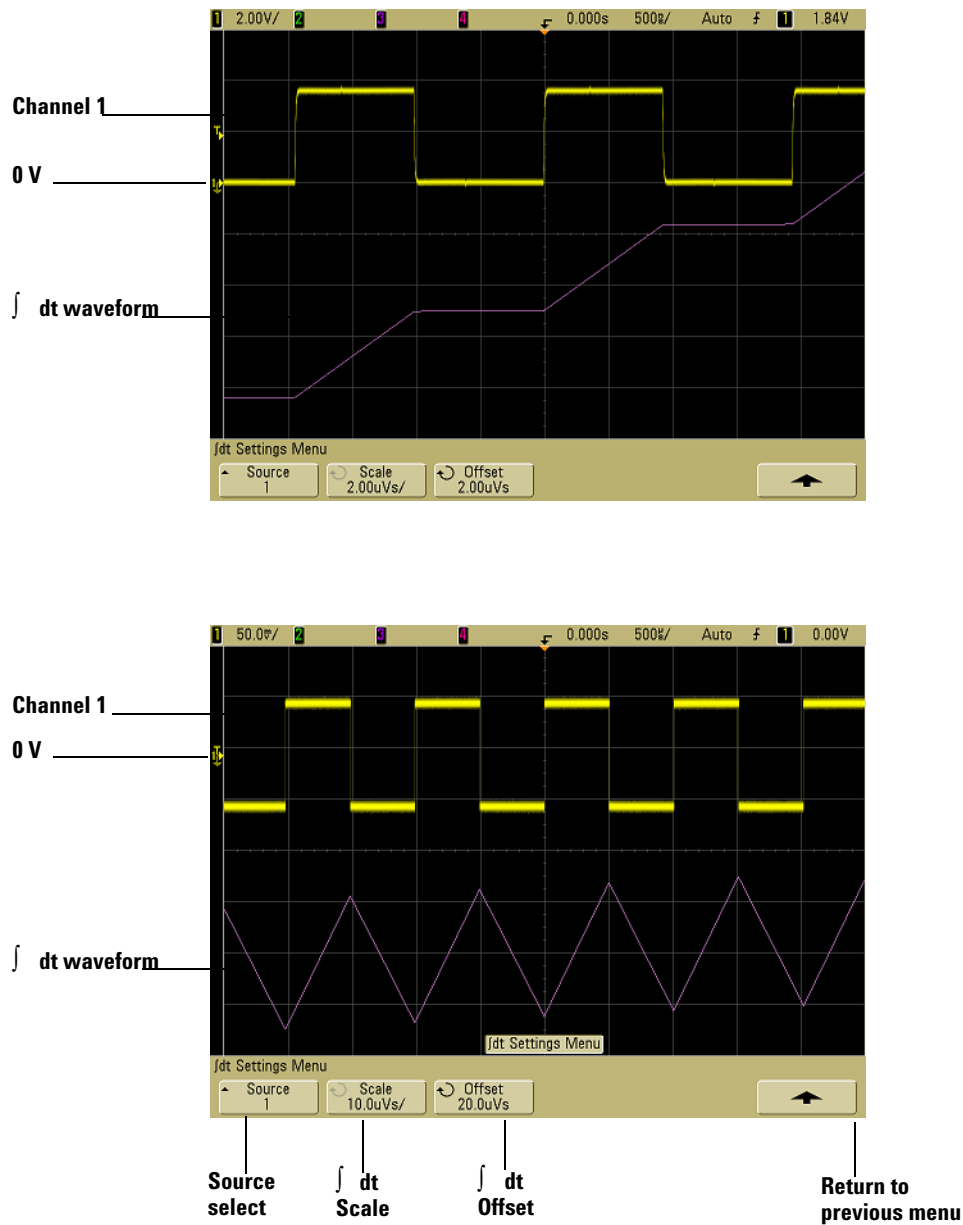

Figure 25 Integrate and Signal Offset

FFT Measurement

FFT is used to compute the fast Fourier transform using analog input channels or math functions 1 + 2, 1 - 2, or 1 * 2. FFT takes the digitized time record of the specified source and transforms it to the frequency domain. When the FFT function is selected, the FFT spectrum is plotted on the oscilloscope display as magnitude in dBV versus frequency. The readout for the horizontal axis changes from time to frequency (Hertz) and the vertical readout changes from volts to dB.

Use the FFT function to find crosstalk problems, to find distortion problems in analog waveforms caused by amplifier non-linearity, or for adjusting analog filters.

FFT Units

0 dBV is the amplitude of a 1 Vrms sinusoid. When the FFT source is channel 1 or channel 2 (or channel 3 or 4 on 4-channel models), FFT units will be displayed in dBV when channel units is set to Volts and channel impedance is set to 1 M Ω

FFT units will be displayed in dBm when channel units is set to Volts and channel impedance is set to 50 Ω

FFT units will be displayed as dB for all other FFT sources or when a source channel's units has been set to Amps.

DC Value

The FFT computation produces a DC value that is incorrect. It does not take the offset at center screen into account. The DC value is not corrected in order to accurately represent frequency components near DC.

Aliasing

When using FFTs, it is important to be aware of frequency aliasing. This requires that the operator have some knowledge as to what the frequency domain should contain, and also consider the sampling rate, frequency span, and oscilloscope

vertical bandwidth when making FFT measurements. The FFT sample rate is displayed directly above the softkeys when the FFT menu is displayed.

Aliasing happens when there are frequency components in the signal higher than half the sample rate. Since the FFT spectrum is limited by this frequency, any higher components are displayed at a lower (aliased) frequency.

The following figure illustrates aliasing. This is the spectrum of a 990 Hz square wave, which has many harmonics. The FFT sample rate is set to 100 kSa/s, and the oscilloscope displays the spectrum. The displayed waveform shows the components of the input signal above the Nyquist frequency to be mirrored (aliased) on the display and reflected off the right edge.

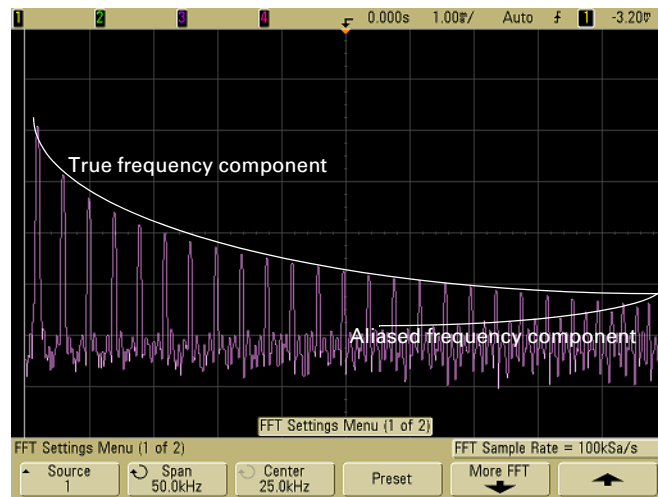

Figure 26 Aliasing

Since the frequency span goes from ≈ 0 to the Nyquist frequency, the best way to prevent aliasing is to make sure that the frequency span is greater than the frequencies of significant energy present in the input signal.

Spectral Leakage

The FFT operation assumes that the time record repeats. Unless there is an integral number of cycles of the sampled waveform in the record, a discontinuity is created at the end of the record. This is referred to as leakage. In order to minimize spectral leakage, windows that approach zero smoothly at the beginning and end of the signal are employed as filters to the FFT. The FFT menu provides three windows: Hanning, flattop, and rectangular. For more information on leakage, see Agilent Application Note 243, “The Fundamentals of Signal Analysis” at <http://cp.literature.agilent.com/litweb/pdf/5952-8898E.pdf>.

FFT Operation

- 1 Press the **Math** key, press the **FFT** softkey, then press the **Settings** softkey to display the FFT menu.

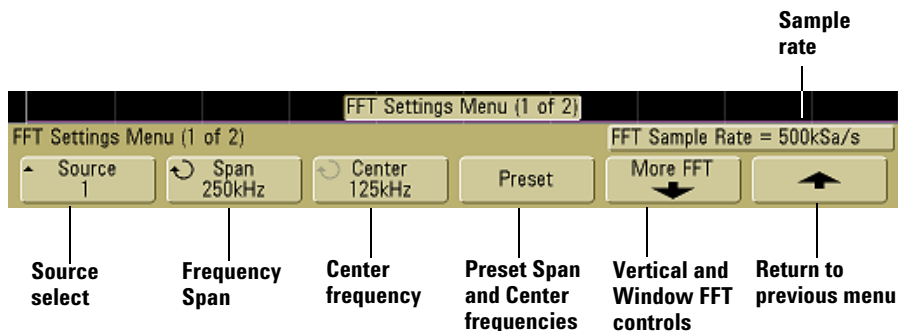

- **Source** – selects the source for the FFT. The source can be any analog channel, or math functions 1 + 2, 1 – 2, and 1 * 2.
- **Span** – sets the overall width of the FFT spectrum that you see on the display (left to right). Divide span by 10 to calculate the number of Hertz per division. It is possible to set Span above the maximum available frequency, in which case the displayed spectrum will not take up the whole screen. Press the **Span** softkey, then turn the Entry knob to set the desired frequency span of the display.

- **Center** – sets the FFT spectrum frequency represented at the center vertical grid line of the display. It is possible to set the Center to values below half the span or above the maximum available frequency, in which case the displayed spectrum will not take up the whole screen. Press the **Center** softkey, then turn the Entry knob to set the desired center frequency of the display.
- **Preset** – sets the frequency Span and Center to values that will cause the entire available spectrum to be displayed. The maximum available frequency is half the effective FFT sample rate, which is a function of the time per division setting. The current FFT sample rate is displayed above the softkeys.

2 Press the More FFT softkey to display additional FFT settings.

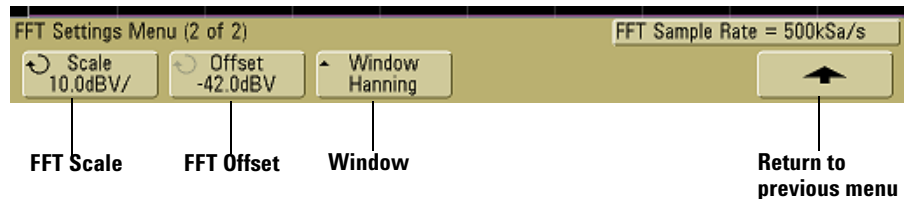

- **Scale** – lets you set your own vertical scale factors for FFT expressed in dB/div (decibels/division). Press the **Scale** softkey, then turn the Entry knob to rescale your math function.
- **Offset** – lets you set your own offset for the FFT. The offset value is in dB and is represented by the center horizontal grid line of the display. Press the **Offset** softkey, then turn the Entry knob to change the offset of your math function.

Scale and offset considerations

If you do not manually change the FFT scale or offset settings, when you turn the horizontal sweep speed knob, the span and center frequency settings will automatically change to allow optimum viewing of the full spectrum. If you do manually set scale or offset, turning the sweep speed knob will not change the span or center frequency settings, allowing you see better detail around a specific frequency. Pressing the FFT **Preset** softkey will automatically rescale the waveform and span and center will again automatically track the horizontal sweep speed setting.

- **Window** – selects a window to apply to your FFT input signal:
- **Hanning** – window for making accurate frequency measurements or for resolving two frequencies that are close together.
- **Flat Top** – window for making accurate amplitude measurements of frequency peaks.
- **Rectangular** – good frequency resolution and amplitude accuracy, but use only where there will be no leakage effects. Use on self-windowing waveforms such as pseudo-random noise, impulses, sine bursts, and decaying sinusoids.

- 3** To make cursors measurements, press the **Cursors** key and set the **Source** softkey to **Math**.

Use the X1 and X2 cursors to measure frequency values and difference between two frequency values (ΔX). Use the Y1 and Y2 cursors to measure amplitude in dB and difference in amplitude (ΔY).

- 4** To make other measurements, press the **Quick Meas** key and set the **Source** softkey to **Math**.

You can make peak-to-peak, maximum, minimum, and average dB measurements on the FFT waveform. You can also find the frequency value at the first occurrence of the waveform maximum by using the X at Max measurement.

The following FFT spectrum was obtained by connecting the front panel Probe Comp signal (~ 1.2 kHz) to channel 1. Set sweep speed to 5 ms/div, vertical sensitivity to 500 mV/div, Units/div to 10 dBV, Offset to -34.0 dBV, Center frequency to 5.00 kHz, frequency Span to 10.0 kHz, and window to Hanning.



Figure 27 FFT measurements

FFT Measurement Hints

The number of points acquired for the FFT record is 1000 and when frequency span is at maximum, all points are displayed. Once the FFT spectrum is displayed, the frequency span and center frequency controls are used much like the controls of a spectrum analyzer to examine the frequency of interest in greater detail. Place the desired part of the waveform at the center of the screen and decrease frequency span to increase the display resolution. As frequency span is decreased, the number of points shown is reduced, and the display is magnified.

While the FFT spectrum is displayed, use the **Math** and **Cursors** keys to switch between measurement functions and frequency domain controls in FFT menu.

Decreasing the effective sampling rate by selecting a slower sweep speed will increase the low frequency resolution of the FFT display and also increase the chance that an alias will be displayed. The resolution of the FFT is the effective sample rate divided by the number of points in the FFT. The actual resolution of the display will not be this fine as the shape of the window will be the actual limiting factor in the FFT's ability to resolve two closely spaced frequencies. A good way to test the ability of the FFT to resolve two closely spaced frequencies is to examine the sidebands of an amplitude modulated sine wave.

For the best vertical accuracy on peak measurements:

- Make sure the probe attenuation is set correctly. The probe attenuation is set from the Channel menu if the operand is a channel.
- Set the source sensitivity so that the input signal is near full screen, but not clipped.
- Use the Flat Top window.
- Set the FFT sensitivity to a sensitive range, such as 2 dB/division.

For best frequency accuracy on peaks:

- Use the Hanning window.
- Use Cursors to place an X cursor on the frequency of interest.
- Adjust frequency span for better cursor placement.
- Return to the Cursors menu to fine tune the X cursor.

For more information on the use of FFTs please refer to Agilent Application Note 243, "The Fundamentals of Signal Analysis" at <http://cp.literature.agilent.com/litweb/pdf/5952-8898E.pdf>. Additional information can be obtained from Chapter 4 of the book "Spectrum and Network Measurements" by Robert A. Witte.

Cursor Measurements

You can measure waveform data using cursors. Cursors are horizontal and vertical markers that indicate X-axis values (usually time) and Y-axis values (usually voltage) on a selected waveform source. The position of the cursors can be moved turning the Entry knob. When you press the **Cursors** key, it will illuminate and the cursors will turn on. To turn cursors off, press this key again until it is not illuminated, or press the **Quick Meas** key.

Cursors are not always limited to the visible display. If you set a cursor, then pan and zoom the waveform until the cursor is off screen, its value will not be changed, and if you pan the waveform back again it will have the cursor in the original place.

To make cursor measurements

A brief description of how to make cursor measurements is given on [page 60](#).

The following steps guide you through the front-panel **Cursors** key. You can use the cursors to make custom voltage or time measurements on the signal.

- 1 Connect a signal to the oscilloscope and obtain a stable display.
- 2 Press the **Cursors** key, then press the **Mode** softkey.

X and Y cursor information is displayed on the softkeys. ΔX , $1/\Delta X$, ΔY , and binary and hexadecimal values are displayed on the line above the softkeys. The three cursors modes are:

- **Normal** – ΔX , $1/\Delta X$, and ΔY values are displayed. ΔX is the difference between the X1 and X2 cursors and ΔY is the difference between the Y1 and Y2 cursors.

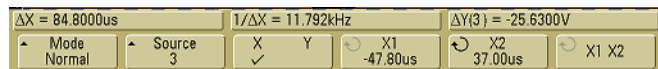

- **Binary** – Binary logic levels are displayed directly above the softkeys for the current X1 and X2 cursor positions for all displayed channels.

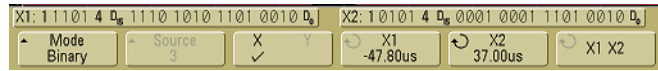

- **Hex** – Hexadecimal logic levels are displayed directly above the softkeys for the current X1 and X2 cursor positions for all displayed channels.

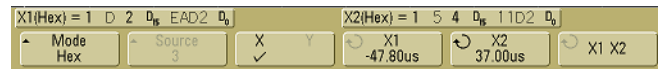

In hexadecimal and binary mode, a level can display as 1 (higher than trigger level), 0 (lower than trigger level), indeterminate state (\updownarrow), or X (don't care). In binary mode, X is displayed if the channel is turned off. In hex mode, the channel is interpreted as a 0 if turned off.

- 3 Press the **Source** softkey to select the analog channel or math source on which the Y cursors will indicate measurements.

The source in **Normal** cursor mode can be any analog channel or math source. If you select binary or hexadecimal mode, the **Source** softkey is disabled since you are displaying binary or hexadecimal levels for all channels.

- 4 Select the X and Y softkeys to make a measurement.

- **X Y** – Press this softkey to select either X cursors or Y cursors for adjustment. The cursor currently assigned to the Entry knob displays brighter than the other cursors.

X cursors are vertical dashed lines that adjust horizontally and normally indicate time relative to the trigger point. When used with the FFT math function as a source, the X cursors indicate frequency.

Y cursors are horizontal dashed lines that adjust vertically and normally indicate Volts or Amps, dependent on the channel **Probe Units** setting. When math functions are used as a source, the measurement units correspond to that math function.

- **X1 and X2** – The X1 cursor (short-dashed vertical line) and X2 cursor (long-dashed-vertical line) adjust horizontally and indicate time relative to the trigger point for all sources except math FFT (frequency is indicated). In XY horizontal mode, the X cursors display channel 1 values (Volts or Amps). The cursor values for the selected waveform source are displayed within the X1 and X2 softkeys.

The difference between X1 and X2 (ΔX) and $1/\Delta X$ are displayed on the dedicated line above the softkeys or in the display area when some menus are selected.

Turn the Entry knob to adjust the X1 or X2 cursor when its softkey is selected.

- **Y1 and Y2** – The Y1 cursor (short-dashed horizontal line) and Y2 cursor (long-dashed horizontal line) adjust vertically and indicate values relative to the waveform's ground point, except math FFT where the values are relative to 0 dB. In XY horizontal mode, the Y cursors display channel 2 values (Volts or Amps). The cursor values for the selected waveform source are displayed within the Y1 and Y2 softkeys.

The difference between Y1 and Y2 (ΔY) is displayed on the dedicated line above the softkeys or in the display area when some menus are selected.

Turn the Entry knob to adjust the Y1 or Y2 cursor when its softkey is selected.

- **X1 X2** – Press this softkey to adjust the X1 and X2 cursors together by turning the Entry knob. The ΔX value will remain the same since the cursors adjust together.

You can adjust the X cursors together to check for pulse width variations in a pulse train.

- **Y1 Y2**— Press this softkey to adjust the Y1 and Y2 cursors together by turning the Entry knob. The ΔY value will remain the same since the cursors adjust together.

Cursor Examples

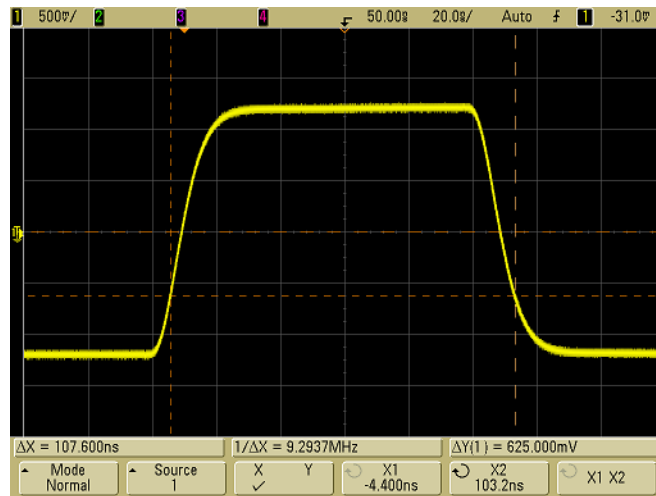

Figure 28 Cursors measure pulse widths other than middle threshold points

5 Making Measurements

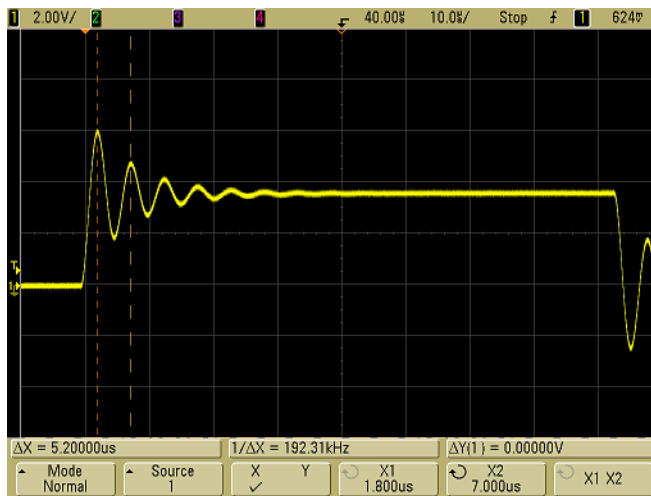

Figure 29 Cursors measure frequency of pulse ringing

Expand the display with delayed sweep, then characterize the event of interest with the cursors.

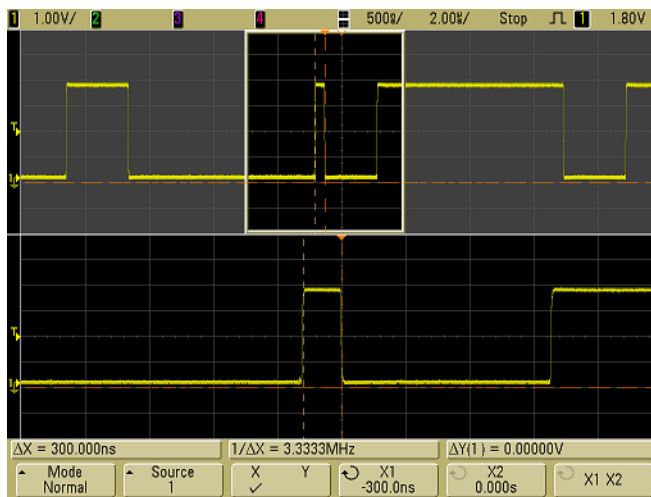

Figure 30 Cursors track delayed sweep

Put the **X1** cursor on one side of a pulse and the **X2** cursor on the other side of the pulse.

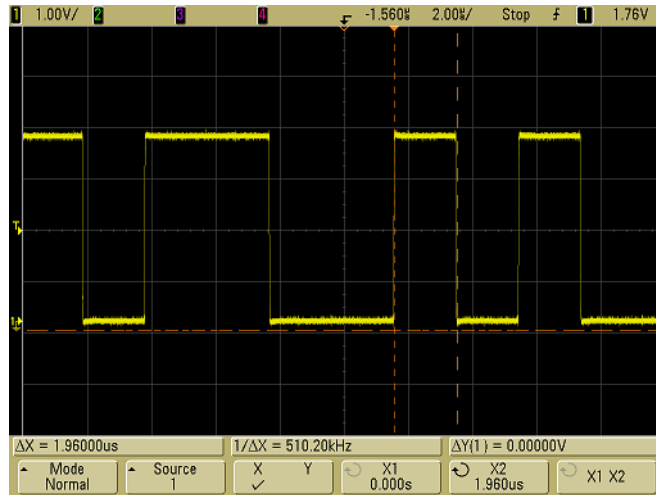

Figure 31 Measuring pulse width with cursors

Press the **X1 X2** softkey and move the cursors together to check for pulse width variations in a pulse train.

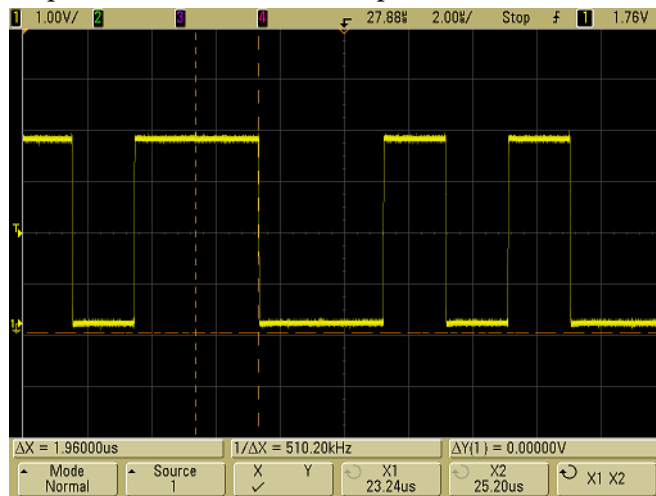

Figure 32 Moving the cursors together to check pulse width variations

Automatic Measurements

The following automatic measurements can be made in the **Quick Meas** menu.

Time Measurements

- Counter
- Duty Cycle
- Frequency
- Period
- Rise Time*
- Fall Time*
- + Width
- – Width
- X at Max*
- X at Min*

Phase and Delay

- Phase*
- Delay*

Voltage Measurements

- Average*
- Amplitude*
- Base*
- Maximum*
- Minimum*
- Peak-to-Peak*
- RMS*
- Std Deviation*
- Top*

Preshoot and Overshoot

- Preshoot*
- Overshoot*

* Measurement on analog channels only.

To make an automatic measurement

A brief description of how to make automatic measurements is given on [page 61](#).

Quick Meas makes automatic measurements on any channel source or any running math function. The results of the last four measurements selected are displayed on the dedicated line above the softkeys, or in the display area when some menus are selected. Quick Meas also makes measurements on stopped waveforms when you are panning and zooming.

Cursors are turned on to show the portion of the waveform being measured for the most recently selected measurement (right-most on the measurement line).

- 1 Press the **Quick Meas** key to display the automatic measurement menu.

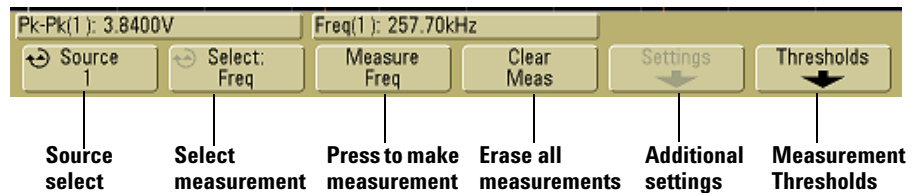

- 2 Press the **Source** softkey to select the channel or running math function on which the quick measurements will be made.

Only channels or math functions that are displayed are available for measurements. If you choose an invalid source channel for a measurement, the measurement will default to the nearest in the list that makes the source valid.

If a portion of the waveform required for a measurement is not displayed or does not display enough resolution to make the measurement, the result will display “No Edges”, “Clipped”, “Low Signal”, “< value”, or “> value”, or a similar message to indicate that the measurement may not be reliable.

- 3 Press the **Clear Meas** softkey to stop making measurements and to erase the measurement results from the display line above the softkeys.

When **Quick Meas** is pressed again, the default measurements will be Frequency and Peak-Peak.

- 4 Press the **Select** softkey then rotate the Entry knob to select a measurement to be made.
- 5 The **Settings** softkey will be available to make additional measurement settings on some measurements.
- 6 Press the **Measure** softkey to make the measurement.
- 7 To turn off **Quick Meas**, press the **Quick Meas** key again until it is not illuminated.

To set measurement thresholds

Setting measurement thresholds defines the vertical levels where measurements will be taken on an analog channel.

Changing default thresholds may change measurement results

The default lower, middle, and upper threshold values are 10%, 50%, and 90% of the value between Top and Base. Changing these threshold definitions from the default values may change the returned measurement results for Average, Delay, Duty Cycle, Fall Time, Frequency, Overshoot, Period, Phase, Preshoot, Rise Time, RMS, +Width, and -Width.

- 1 Press the **Thresholds** softkey in the **Quick Meas** menu to set analog channel measurement thresholds.
- 2 Press the **Source** softkey to select the analog channel source for which you want to change measurement thresholds. Each analog channel can be assigned unique threshold values.

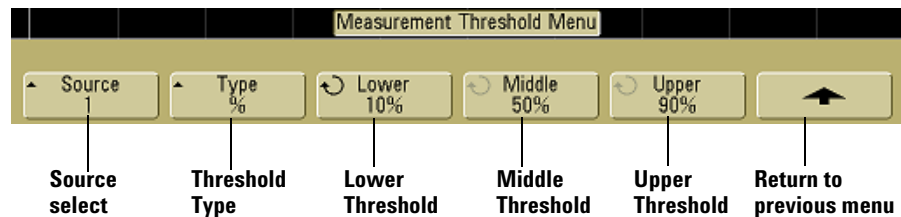

- 3 Press the **Type** softkey to set the measurement threshold to % (percentage of Top and Base value) or to **Absolute** (absolute value.)
 - Percentage thresholds can be set from 5% to 95%.
 - The units for absolute threshold for each channel is set in the channel probe menu.

Absolute threshold hints

- Absolute thresholds are dependent on channel scaling, probe attenuation, and probe units. Always set these values first before setting absolute thresholds.
- The minimum and maximum threshold values are limited to on-screen values.
- If any of the absolute threshold values are above or below the minimum or maximum waveform values, the measurement may not be valid.

- 4 Press the **Lower** softkey, then turn the Entry knob to set the lower measurement threshold value.

Increasing the lower value beyond the set middle value will automatically increase the middle value to be more than the lower value. The default lower threshold is 10% or 800 mV.

If threshold **Type** is set to %, the lower threshold value can be set from 5% to 93%.

- 5 Press the **Middle** softkey, then turn the Entry knob to set the middle measurement threshold value.

The middle value is bounded by the values set for lower and upper thresholds. The default middle threshold is 50% or 1.20 V.

- If threshold **Type** is set to %, the middle threshold value can be set from 6% to 94%.

6 Press the **Upper** softkey, then turn the Entry knob to set the upper measurement threshold value.

Decreasing the upper value below the set middle value will automatically decrease the middle value to be less than the upper value. The default upper threshold is 90% or 1.50 V.

- If threshold **Type** is set to %, the upper threshold value can be set from 7% to 95%.

Time Measurements

FFT measurements

When you make an **X at Max** or **X at Min** measurement on a math FFT function, the resultant units will be in Hertz. No other time related automatic measurement can be made on the FFT math function. Use the cursors to make other measurements on FFT.

The default lower, middle, and upper measurement thresholds are 10%, 50%, and 90% between Top and Base values. See [“To set measurement thresholds”](#) on page 184 for other percentage threshold and absolute value threshold settings.

The following figure shows time measurement points.

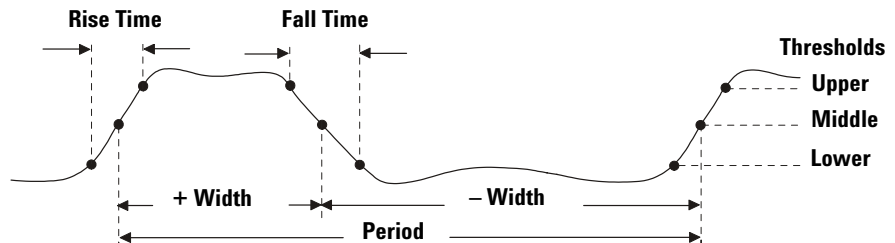

Digital channel time measurements

Automatic time measurements **Delay, Fall Time, Phase, Rise Time, X at Max, and X at Min**, and are not valid for digital channels on mixed-signal oscilloscopes.

Counter

The 6000 Series oscilloscopes have an integrated hardware frequency counter which counts the number of cycles that occur within a period of time (known as the *gate time*) to measure the frequency of a signal.

The gate time for the Counter measurement is automatically adjusted to be 100 ms or twice the current time window, whichever is longer, up to 1 second.

The Counter can measure frequencies up to the bandwidth of the oscilloscope. The minimum frequency supported is $1/(2 \times \text{gate time})$.

The measured frequency is normally displayed in 5 digits, but can be displayed in 8 digits when an external 10 MHz frequency reference is provided at the 10 MHz REF rear panel BNC and the gate time is 1 second (50 ms/div sweep speed or greater). See (“[To supply a sample clock to the oscilloscope](#)” on page 267.)

The hardware counter uses the trigger comparator output. Therefore, the counted channel’s trigger level (or threshold for digital channels) must be set correctly. The Y cursor shows the threshold level used in the measurement.

Any channel except Math can be selected as the source.

Only one Counter measurement can be displayed at a time.

Duty Cycle

The duty cycle of a repetitive pulse train is the ratio of the positive pulse width to the period, expressed as a percentage. The X cursors show the time period being measured. The Y cursor shows the middle threshold point.

$$\text{Duty cycle} = \frac{\text{Width}}{\text{Period}} \times 100$$

Frequency

Frequency is defined as $1/\text{Period}$. Period is defined as the time between the middle threshold crossings of two consecutive, like-polarity edges. A middle threshold crossing must also travel through the lower and upper threshold levels which eliminates runt pulses. The X cursors show what portion of the waveform is being measured. The Y cursor shows the middle threshold point.

To isolate an event for frequency measurement The following figure shows how to use delayed sweep to isolate an event for a frequency measurement. If the measurement is not possible in the delayed time base mode, then the main time base is used. If the waveform is clipped, it may not be possible to make the measurement.

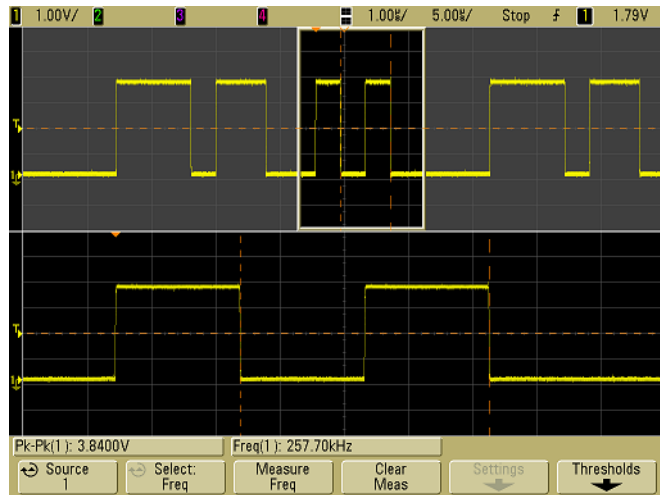

Table 11 Isolating event for Frequency measurement

Period

Period is the time period of the complete waveform cycle. The time is measured between the middle threshold points of two consecutive, like-polarity edges. A middle threshold crossing must also travel through the lower and upper threshold levels

which eliminates runt pulses. The X cursors show what portion of the waveform is being measured. The Y cursor shows the middle threshold point.

Fall Time

The fall time of a signal is the time difference between the crossing of the upper threshold and the crossing of the lower threshold for a negative-going edge. The X cursor shows the edge being measured. For maximum measurement accuracy, set the sweep speed as fast as possible while leaving the complete falling edge of the waveform on the display. The Y cursors show the lower and upper threshold points.

Rise Time

The rise time of a signal is the time difference between the crossing of the lower threshold and the crossing of the upper threshold for a positive-going edge. The X cursor shows the edge being measured. For maximum measurement accuracy, set the sweep speed as fast as possible while leaving the complete rising edge of the waveform on the display. The Y cursors show the lower and upper threshold points.

+ Width

+ Width is the time from the middle threshold of the rising edge to the middle threshold of the next falling edge. The X cursors show the pulse being measured. The Y cursor shows the middle threshold point.

– Width

– Width is the time from the middle threshold of the falling edge to the middle threshold of the next rising edge. The X cursors show the pulse being measured. The Y cursor shows the middle threshold point.

X at Max

X at Max is the X axis value (usually time) at the first displayed occurrence of the waveform Maximum, starting from the left-side of the display. For periodic signals, the position of the maximum may vary throughout the waveform. The X cursor shows where the current X at Max value is being measured.

To measure the peak of an FFT:

- 1 Select **FFT** as the math function in the **Math** menu.
- 2 Choose **Math** as the source in the **Quick Meas** menu.
- 3 Choose **Maximum** and **X at Max** measurements.

Maximum units are in dB and **X at Max** units are in Hertz for FFT.

X at Min

X at Min is the X axis value (usually time) at the first displayed occurrence of the waveform Minimum, starting from the left-side of the display. For periodic signals, the position of the minimum may vary throughout the waveform. The X cursor shows where the current X at Min value is being measured.

Delay and Phase Measurements

Digital channel measurements

Automatic measurements **Phase**, and **Delay** are not valid for digital channels on the mixed-signal oscilloscope or for the math FFT function. The two sources defined in the phase and delay measurement must be turned on.

Delay

Delay measures the time difference from the selected edge on source 1 and the selected edge on source 2 closest to the trigger reference point at the middle threshold points on the waveforms. Negative delay values indicate that the selected edge of source 1 occurred after the selected edge of source 2.

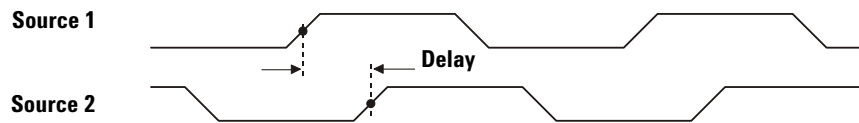

- 1 Press the **Quick Meas**→**Select** and select **Delay**. Press the **Settings** softkey to select the source channels and slope for the delay measurement.

The default Delay settings measure from the rising edge of channel 1 to the rising edge of channel 2.

- 2 Press the **Measure Delay** softkey to make the measurement.

The following example shows a delay measurement between the rising edge of channel 1 and the rising edge of channel 2.

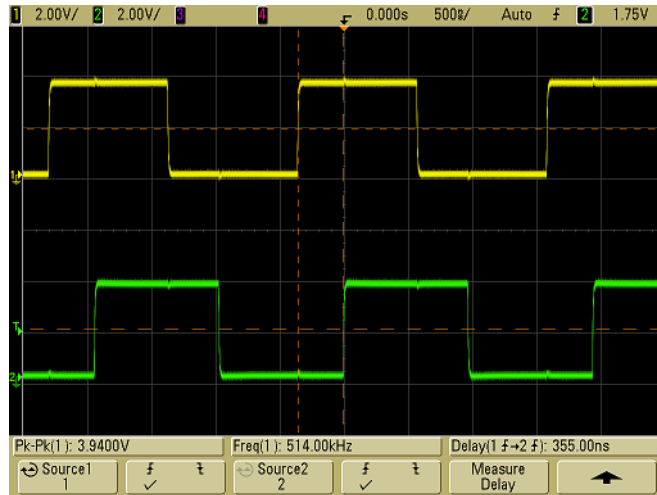
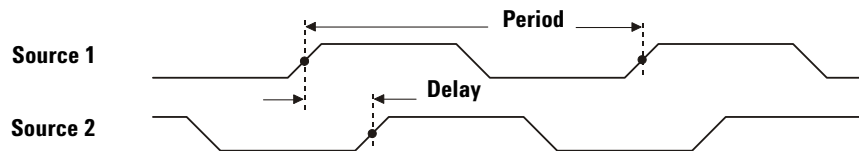

Figure 33 Delay Measurement

Phase

Phase is the calculated phase shift from source 1 to source 2, expressed in degrees. Negative phase shift values indicate that the rising edge of source 1 occurred after the rising edge of source 2.

$$\text{Phase} = \frac{\text{Delay}}{\text{Source 1 Period}} \times 360$$



- 1 Press the **Settings** softkey to select the source 1 and source 2 channels for the phase measurement.

The default Phase settings measure from channel 1 to channel 2.

The example below shows a phase measurement between the channel 1 and the math d/dt function on channel 1.

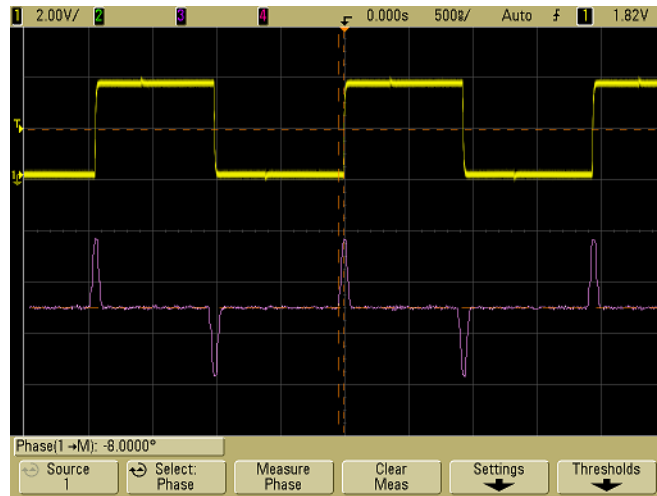

Figure 34 Phase Measurement

Voltage Measurements

Measurement units for each input channel can be set to Volts or Amps using the channel **Probe Units** softkey. A scale unit of **U** (undefined) will be displayed for math function 1-2 and for d/dt, and $\int dt$ when 1-2 or 1+2 is the selected source if channel 1 and channel 2 are set to dissimilar units in the channel **Probe Units** softkey.

Math Measurements and Units

Only Peak-Peak, Maximum, Minimum, Average, X at Min, and X at Max automatic measurements may be made on a math FFT function. See “Making time measurements automatically” for the FFT X at Max and X at Min measurement. Use the cursors to make other measurements on FFT. All voltage measurements may be made on other math functions. The resultant units are:

- FFT: dB* (decibels)
- 1 * 2: V², A² or W (Volt-Amp)
- 1 – 2: V (Volts) or A (Amps)
- d/dt: V/s or A/s (V/second A/second)
- ∫ dt: Vs or As (V-seconds or A-seconds)

* When the FFT source is channel 1, 2, 3, or 4, FFT units will be displayed in dBV when channel units is set to Volts and channel impedance is set to 1 MΩ FFT units will be displayed in dBm when channel units is set to Volts and channel impedance is set to 50Ω FFT units will be displayed as dB for all other FFT sources or when a source channel’s units has been set to Amps.

The following figure shows the voltage measurement points.

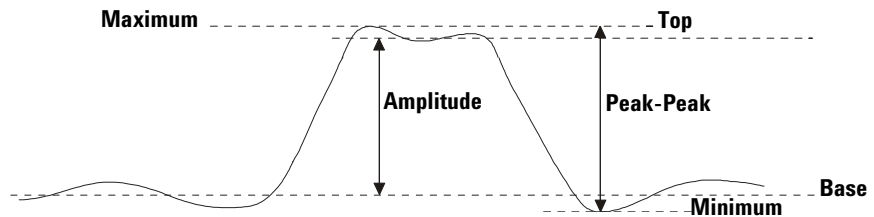

Digital channel voltage measurements

Automatic voltage measurements are not valid on digital channels on the mixed-signal oscilloscope.

Amplitude

The Amplitude of a waveform is the difference between its Top and Base values. The Y cursors show the values being measured.

Average

Average is the sum of the waveform samples divided by the number of samples over one or more full periods. If less than one period is displayed, Average is calculated on the full width of the display. The X cursors show what portion of the displayed waveform is being measured.

$$\text{Average} = \frac{\sum x_i}{n} \quad \begin{array}{l} \text{where } x_i = \text{value at } i\text{th point being measured} \\ n = \text{number of points in measurement interval} \end{array}$$

Base

The Base of a waveform is the mode (most common value) of the lower part of the waveform, or if the mode is not well defined, the base is the same as Minimum. The Y cursor shows the value being measured.

Maximum

Maximum is the highest value in the waveform display. The Y cursor shows the value being measured.

Minimum

Minimum is the lowest value in the waveform display. The Y cursor shows the value being measured.

Peak-Peak

The peak-to-peak value is the difference between Maximum and Minimum values. The Y cursors show the values being measured.

RMS

RMS (DC) is the root-mean-square value of the waveform over one or more full periods. If less than one period is displayed, RMS (DC) average is calculated on the full width of the display. The X cursors show what interval of the waveform is being measured.

$$\text{RMS (dc)} = \sqrt{\frac{\sum_{i=1}^n x_i^2}{n}}$$

where x_i = value at i th point being measured
 n = number of points in measurement interval

Std Deviation

The Std Deviation measurement shows the standard deviation of the displayed voltage values. It is an RMS measurement across the full screen with the DC component removed. It is useful, for example, for measuring power supply noise.

The standard deviation of a measurement is the amount that a measurement varies from the mean value. The Mean value of a measurement is the statistical average of the measurement.

The following figure graphically shows the mean and standard deviation. Standard deviation is represented by the Greek letter sigma: σ . For a Gaussian distribution, two sigma ($\pm 1\sigma$) from the mean, is where 68.3 percent of the measurement results reside. Six sigma ($\pm 3\sigma$) from is where 99.7 percent of the measurement results reside.

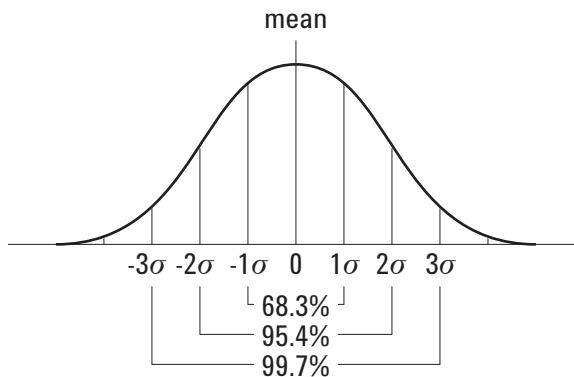

The mean is calculated as follows:

$$\bar{x} = \frac{\sum_{i=1}^N x_i}{N}$$

where:

\bar{x} = the mean.

N = the number of measurements taken.

x_i = the i^{th} measurement result.

The standard deviation is calculated as follows:

$$\sigma = \sqrt{\frac{\sum_{i=1}^N (x_i - \bar{x})^2}{N - 1}}$$

where:

σ = the standard deviation.

N = the number of measurements taken.

x_i = the i^{th} measurement result.

\bar{x} = the mean.

Top

The Top of a waveform is the mode (most common value) of the upper part of the waveform, or if the mode is not well defined, the top is the same as Maximum. The Y cursor shows the value being measured.

To isolate a pulse for Top measurement The following figure shows how to use delayed sweep to isolate a pulse for a **Top** measurement.

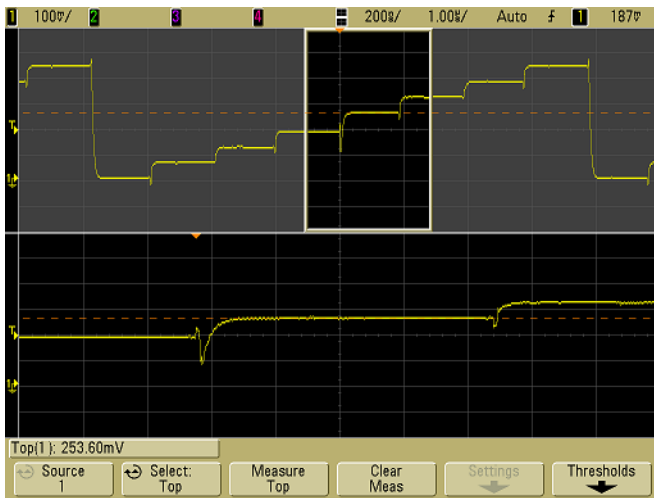

Figure 35 Isolating area for Top measurement

Overshoot and Preshoot Measurements

Digital channel time measurements

Automatic measurements **Preshoot** and **Overshoot** are not valid measurements for the math FFT function or for digital channels on the mixed-signal oscilloscope.

Preshoot

Preshoot is distortion that precedes a major edge transition expressed as a percentage of Amplitude. The X cursors show which edge is being measured (edge closest to the trigger reference point).

$$\text{Rising edge preshoot} = \frac{\text{Base} - \text{D local Minimum}}{\text{Amplitude}} \times 100$$

$$\text{Falling edge preshoot} = \frac{\text{local Maximum} - \text{D Top}}{\text{Amplitude}} \times 100$$

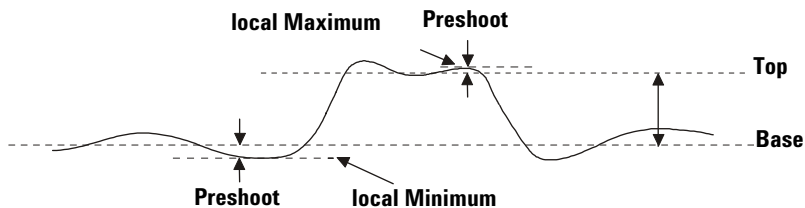

Overshoot

Overshoot is distortion that follows a major edge transition expressed as a percentage of Amplitude. The X cursors show which edge is being measured (edge closest to the trigger reference point).

$$\text{Rising edge overshoot} = \frac{\text{local Maximum} - \text{D Top}}{\text{Amplitude}} \times 100$$

$$\text{Falling edge overshoot} = \frac{\text{Base} - \text{D local Minimum}}{\text{Amplitude}} \times 100$$

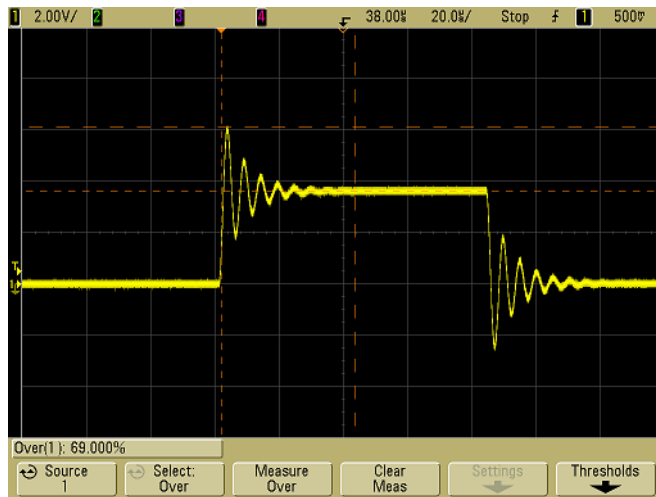
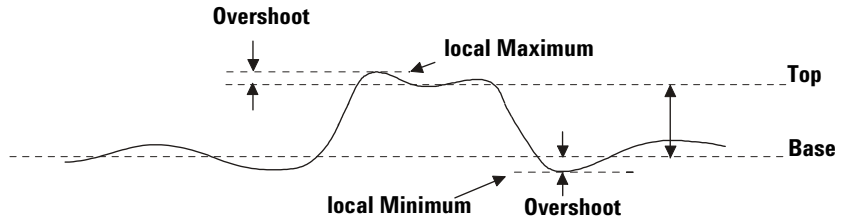

Figure 36 Automatic Overshoot measurement



6 Displaying Data

- Pan and Zoom [202](#)
- Antialiasing [204](#)
- Using the XGA video output [204](#)
- Display Settings [205](#)
- Varying the intensity to view signal detail [207](#)
- Acquisition Modes [209](#)
- Using Serial Decode [215](#)
 - To decode I²C data [216](#)
 - To decode SPI data [220](#)
 - To decode CAN data [225](#)
 - To decode LIN data [232](#)
 - To reduce the random noise on a signal [238](#)
 - To capture glitches or narrow pulses with peak detect and infinite persistence [240](#)
- How Autoscale Works [243](#)



Pan and Zoom

The ability to pan (move horizontally) and zoom (expand or compress horizontally) an acquired waveform is important because of the additional insight it can reveal about the captured waveform. This additional insight is often gained from seeing the waveform at different levels of abstraction. You may want to view both the big picture and the specific little picture details.

The ability to examine waveform detail after the waveform has been acquired is a benefit generally associated with digital oscilloscopes. Often this is simply the ability to freeze the display for the purpose of measuring with cursors or printing the screen. Some digital oscilloscopes go one step further by including the ability to further examine the signal details after acquiring them by panning and zooming through the waveform.

There is no limit imposed on the zoom ratio between the sweep speed used to acquire the data and the sweep speed used to view the data. There is, however, a useful limit. This useful limit is somewhat a function of the signal you are analyzing.

In normal display mode, with vectors (connect-the-dots) off, you can zoom in to the point where there are no samples on the screen. Obviously, this is far beyond the useful limit. Likewise, with vectors on, you can see the linear interpolation between the points, but again, this is of very limited value.

Zoom

The screen will still contain a relatively good display if you zoom in horizontally by a factor of 1000 and zoom in vertically by a factor of 10 to display the information from where it was acquired. Remember that you can only make automatic measurements on displayed data.

To pan and zoom a waveform

- 1 Press the **Run/Stop** key to stop acquisitions. The **Run/Stop** key is illuminated red when the oscilloscope is stopped.
- 2 Turn the sweep speed knob to zoom horizontally and turn the volts/division knob to zoom vertically.

The ∇ symbol at the top of the display indicates the time reference point where the zoom-in/zoom-out is referenced.

- 3 Turn the Delay Time knob ($\blacktriangleleft\blacktriangleright$) to pan horizontally and turn the channel's vertical position knob (\blacklozenge) to pan vertically.

The stopped display may contain several triggers worth of information, but only the last trigger acquisition is available for pan and zoom.

To set the waveform expansion reference point

When you change a channel's volts/division setting, the waveform display can be set to expand (or compress) about the signal ground level or the center of the display.

Expand About Ground The displayed waveform will expand about the position of the channel's ground. This is the default setting. The ground level of the signal is identified by the position of the ground level (\blacktriangleleft) icon at the far-left side of the display. The ground level will not move when you adjust the vertical sensitivity (volts/division) control.

If the ground level is off screen, the waveform will expand about the top or bottom edge of the screen based on where the ground is off screen.

Expand About Center The displayed waveform will expand about the center of the display.

To set the waveform expansion reference point

Press **Utility**→**Options**→**Preferences**→**Expand** and select **Ground** or **Center**.

Antialiasing

At slower sweep speeds, the sample rate is reduced and a proprietary display algorithm is used to minimize the likelihood of aliasing.

By default, Antialiasing is enabled. You should leave Antialiasing enabled unless there is a specific reason to switch it off.

If you need to switch Antialiasing off, press **Utilities**→**Options**→**Preferences** and press the **Antialiasing** softkey to switch the feature off. The displayed waveforms will be more susceptible to aliasing.

Using the XGA video output

A standard XGA video output connector is provided on the rear panel. You can connect a monitor to provide a larger display, or to provide a display at a viewing position away from the oscilloscope.

The oscilloscope's built-in display will remain on even when an external display is connected.

Display Settings

- Press the **Display** key to view the Display menu.

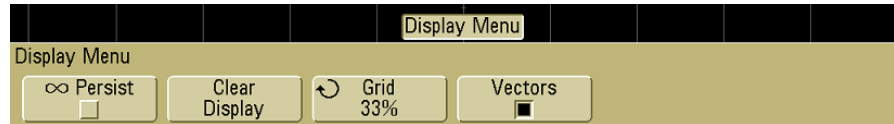

Infinite persistence

With infinite persistence, the oscilloscope updates the display with new acquisitions, but does not erase the results of previous acquisitions. All previous acquisitions are displayed in gray with reduced intensity. New acquisitions are shown in normal color with normal intensity. Waveform persistence is not kept beyond the display area boundary.

Use infinite persistence to measure noise and jitter, to see the worst-case extremes of varying waveforms, to look for timing violations, or to capture events that occur infrequently.

To use infinite persistence to display multiple repetitive events

- 1 Connect a signal to the oscilloscope.
- 2 Press the **Display** key, then press ∞ **Persist** to turn on infinite persistence. The display will begin accumulating multiple acquisitions. The accumulated waveforms are shown in gray with reduced intensity.
- 3 Press the **Clear Display** softkey to erase previous acquisitions. The oscilloscope will again start to accumulate acquisitions.
- 4 Turn off infinite persistence, then press the **Clear Display** key to return the oscilloscope to the normal display mode.

Accumulating multiple acquisitions

Turning off infinite persistence does not clear the display. This allows you to accumulate multiple acquisitions, stop acquisitions, and then compare future acquisitions to the stored waveforms.

Clearing stored infinite persistence waveforms

In addition to clearing the display by pressing the **Clear Display** softkey, the display is also cleared of previous acquisitions if you press the **Autoscale** key.

Grid intensity

To adjust the grid (graticule) intensity, press **Display→Grid** and use the Entry knob  to adjust the intensity.

Vectors (connect the dots)

The Agilent 6000 Series oscilloscopes are designed to operate optimally with vectors on. This mode gives the most realistic waveforms in most situations.

When enabled, **Vectors** draws a line between consecutive waveform data points.

- Vectors give an analog look to a digitized waveform.
- Vectors allow you to see steep edges on waveforms, such as square waves.
- Vectors allow subtle detail of complex waveforms to be viewed, much like an analog oscilloscope trace, even when the detail is just a small number of pixels in size.

The oscilloscope switches vectors on whenever the acquisition system stops. Digital channels on the mixed-signal oscilloscope are not affected by the Display menu. They are always displayed with peak detect and vectors on. They also only contain one trigger worth of information.

Using Vectors (Display menu)

One of the most fundamental choices you must make about your display is whether to draw vectors (connect the dots) between the samples, or simply let the samples fill in the waveform. To some degree, this is a matter of personal preference, but it also depends on the waveform.

- You will probably operate the oscilloscope most often with vectors on. Complex analog signals like video and modulated signals show analog-like intensity information with vectors on.
- Turn vectors off when highly complex or multivalued waveforms are displayed. Turning vectors off may aid the display of multivalued waveforms such as eye diagrams.
- Having vectors on does not slow down the display rate.

Varying the intensity to view signal detail

The **Intensity** knob lets you adjust the plotted waveforms to account for various signal characteristics, such as fast sweep speeds and low trigger rates. Increasing the intensity lets you see the maximum amount of noise and infrequently occurring events. Reducing the intensity can expose more detail in complex signals as shown in the following figures. The intensity knob does not affect the digital channels.

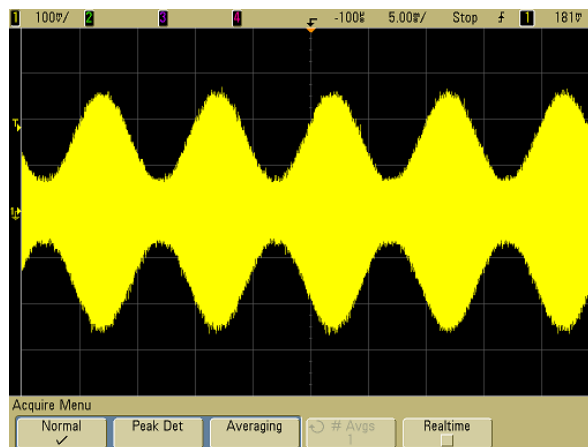

Figure 37 Amplitude Modulation with Noise Shown at 100% Intensity

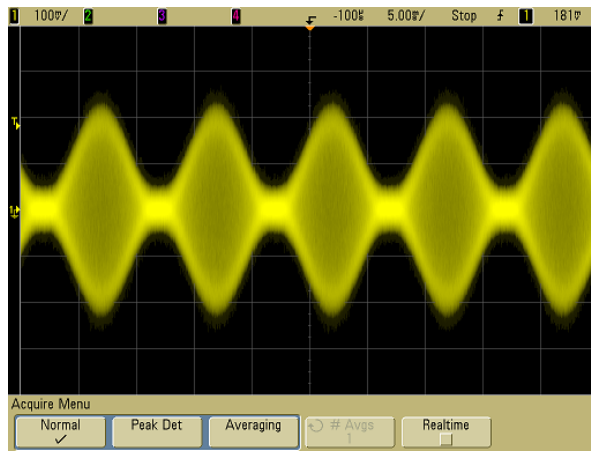

Figure 38 Amplitude Modulation with Noise Shown at 40% Intensity

Acquisition Modes

The 6000 Series oscilloscopes have the following acquisition modes:

- **Normal** – for most waveforms (with normal decimating at slower sweep speeds, no averaging).
- **Peak Detect** – for displaying narrow pulses that occur infrequently (at slower sweep speeds).
- **Averaging** – for reducing noise and increasing resolution (at all sweep speeds, without bandwidth or rise time degradation).
- **High Resolution** – for reducing random noise (at slower sweep speeds).

Realtime sampling (where the oscilloscope produces the waveform display from samples collected during one trigger event) can be turned off or on in the Normal, Peak Detect, and High Resolution modes.

At Slower Sweep Speeds

At slower sweep speeds, the sample rate drops because the acquisition time increases and the oscilloscope's digitizer is sampling faster than it needs to fill memory.

For example, suppose an oscilloscope's digitizer has a sample period of 1 ns (maximum sample rate of 1 GSa/s) and a 1 M memory depth. At that rate, memory is filled in 1 ms. If the acquisition time is 100 ms (10 ms/div), only 1 of every 100 samples is needed to fill memory.

Normal Mode

In Normal mode at slower sweep speeds, extra samples are decimated (in other words, some are thrown away). This mode yields the best display for most waveforms.

Peak Detect Mode

In Peak Detect mode at slower sweep speeds, minimum and maximum samples are kept in order to capture infrequent and narrow events (at the expense of exaggerating any noise). This mode displays all pulses that are at least as wide as the sample period (see [Table 12](#)).

Table 12 Agilent 6000 Series Model Numbers and Sampling Rates

Bandwidth	100 MHz	300 MHz	500 MHz	1 GHz
Maximum Sample Rate	2 GSa/s	2 GSa/s	4 GSa/s	4 GSa/s
A sample is taken every (sample period)	500 ps	500 ps	250 ps	250 ps
2-Channel DSO	DSO6012A	DSO6032A	DSO6052A	DSO6102A
4-Channel DSO	DSO6014A	DSO6034A	DSO6054A	DSO6104A
2-Channel + 16 Logic Channels MSO	MSO6012A	MSO6032A	MSO6052A	MSO6102A
4-Channel + 16 Logic Channels MSO	MSO6014A	MSO6034A	MSO6054A	MSO6104A

High Resolution Mode

In High Resolution mode at slower sweep speeds, extra samples are averaged in order to reduce random noise (and produce a smoother trace on the screen).

The slower the sweep speed, the greater the number of samples that are averaged together for each display point.

High Resolution mode is equivalent to the Averaging mode with #Averages=1 (except you can still turn on Realtime sampling in the High Resolution mode). Averaging has the effect of increasing vertical resolution.

2 GSa/s Sample Rate	4 GSa/s Sample Rate	Bits of resolution (# Avgs=1)
≤50 ns/div	≤50 ns/div	8
200 ns/div	100 ns/div	9
1 us/div	500 ns/div	10
5 us/div	2 us/div	11
≥20 us/div	≥10 us/div	12

Averaging Mode

The Averaging mode lets you average multiple acquisitions together to reduce noise and increase vertical resolution (at all sweep speeds). Averaging requires a stable trigger.

The number of averages can be set from 1 to 65536 in powers-of-2 increments.

A higher number of averages reduces noise more and increases vertical resolution.

# Avgs	Bits of resolution
2	8
4	9
16	10
64	11
≥256	12

The higher the number of averages, the slower the displayed waveform responds to waveform changes. You must compromise between how quickly the waveform responds to changes and how much you want to reduce the displayed noise on the signal.

To use the Averaging mode

- 1 Press the **Acquire** key, then press the **Acq Mode** softkey until the Averaging mode is selected.
- 2 Press the **#Avgs** softkey and turn the Entry knob to set the number of averages that best eliminates the noise from the displayed waveform. The number of acquisitions being averaged is displayed in the **# Avgs** softkey.

6 Displaying Data

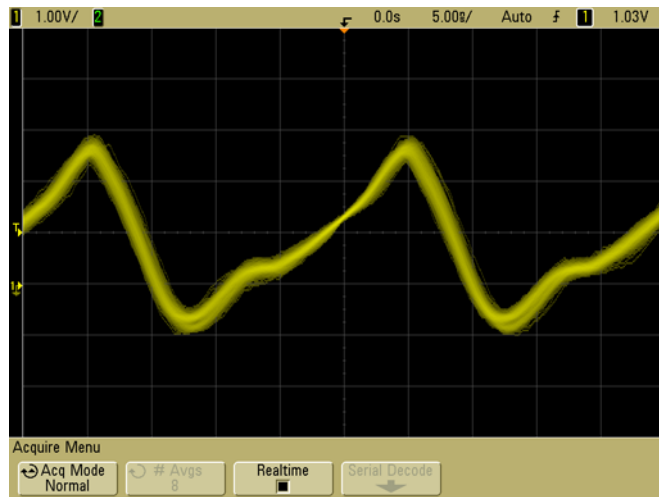

Figure 39 Random noise on the displayed waveform

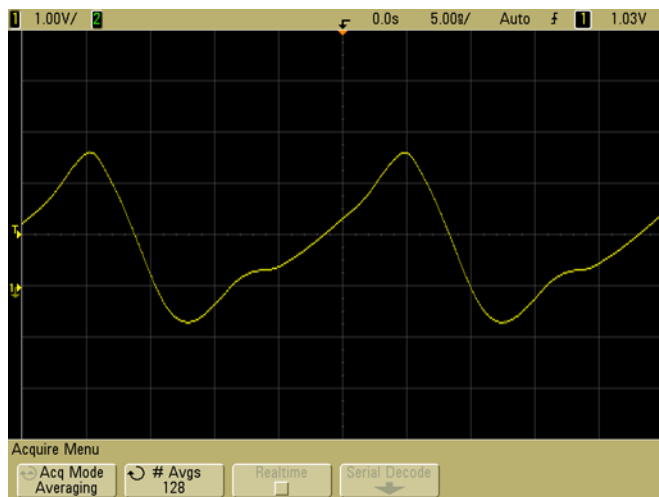

Figure 40 128 Averages used to reduce random noise

Realtime Sampling Option

Realtime sampling specifies that the oscilloscope produce the waveform display from samples collected during one trigger event (that is, one acquisition).

Use Realtime sampling to capture infrequent triggers, unstable triggers, or complex changing waveforms, such as eye diagrams.

Realtime sampling can be turned on in **Normal**, **Peak Detect**, or **High Resolution** acquisition modes. It cannot be turned on when the acquisition mode is **Averaging**.

When Realtime sampling is on (as in the default setup):

- When less than 1000 samples can be collected in the time spanned by the screen, a sophisticated reconstruction filter is used to fill in and enhance the waveform display.
- If you press the **Stop** key, and pan and zoom through the waveform using the Horizontal and Vertical controls, only the last trigger's acquisition will be displayed.

When Realtime sampling is off:

- The oscilloscope produces the waveform display from samples collected from multiple acquisitions. In this case, the reconstruction filter is not used.

Realtime Sampling and Oscilloscope Bandwidth

To accurately reproduce a sampled waveform, the sample rate should be at least four times the highest frequency component of the waveform. If not, it is possible for the reconstructed waveform to be distorted or aliased. Aliasing is most commonly seen as jitter on fast edges.

The maximum sample rate for 100 MHz and 300 MHz bandwidth oscilloscopes is 2 GSa/s.

The maximum sample rate for 1 GHz and 500 MHz bandwidth oscilloscopes is 4 GSa/s for a single channel in a channel pair. Channels 1 and 2 constitute a channel pair, and channels 3 and 4 constitute another channel pair. For example, the sample rate of a 4-channel oscilloscope is 4 GSa/s when channels 1 and 3, 1 and 4, 2 and 3, or 2 and 4 are on.

Whenever both channels in a channel pair are on, the sample rate for all channels is halved. For example, when channels 1, 2, and 3 are on, the sample rate for all channels is 2 GSa/s.

When Realtime sampling is on, the bandwidth of the oscilloscope is limited because the bandwidth of the reconstruction filter is set to $f_s/4$. For example, a 610x oscilloscope with channels 1 and 2 on has a bandwidth is 500 MHz when Realtime sampling on and 1 GHz when Realtime sampling is off.

To see the sample rate, press the **Main/Delayed** key on the front panel. The sample rate is displayed in the line just above the softkeys.

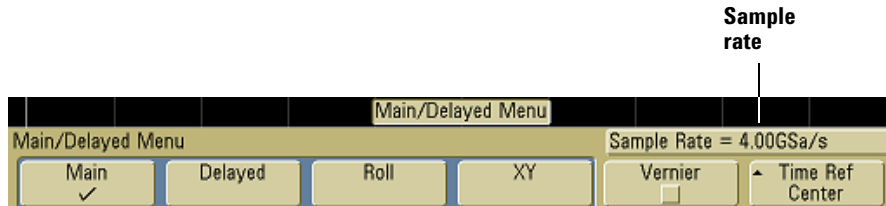

Using Serial Decode

Agilent's hardware accelerated serial decode options can be licensed on 4-channel or 4+16-channel 6000 Series oscilloscopes. Two serial decode licenses are available:

- The N5423A (Option LSS) license provides the ability to decode I²C (Inter-IC) and SPI (Serial Peripheral Interface) serial busses.
- The N5424A (Option AMS) license provides the ability to decode CAN (Controller Area Network) and LIN (Local Interconnect Network) serial busses.

Adding the Automotive Serial (AMS) serial decode license will add more CAN and LIN trigger types. See [page 107](#) or [page 122](#) for details.

To determine whether these licenses are installed on your oscilloscope press the **Utility** key, then press the **Options** softkey, the **Features** softkey, and the **Show license information** softkey.

To order serial decode licenses, contact your local Agilent Technologies representative (see www.agilent.com/find/contactus).

To decode I²C data

NOTE

Because of oscilloscope hardware resource limitations, you cannot decode I²C data while LIN triggering is selected.

NOTE

For I²C triggering setup see [page 114](#).

- 1 Select the I²C serial decode mode:
 - a Press the **Acquire** key.
 - b Press the **Serial Decode** softkey.

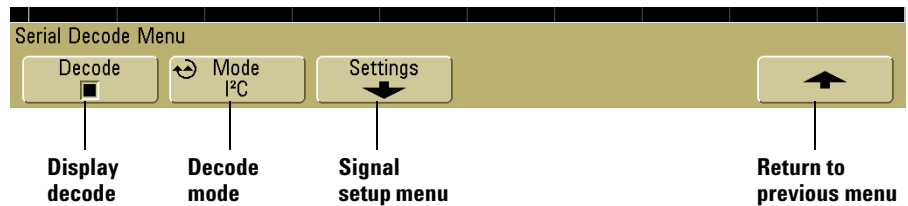

- c In the Serial Decode Menu, press the **Mode** softkey.
 - d Use the Entry knob (or repeatedly press and release the **Mode** softkey) to select the **I²C** serial decode mode.

2 Specify the I²C signals:

NOTE

If you have already set up an I²C trigger, the signals have already been specified, and you can continue on with [step 4](#).

Changing I²C signals in the Serial Decode setup also changes them in the Trigger setup.

a Press the **Settings** softkey to access the I²C Signals Menu.

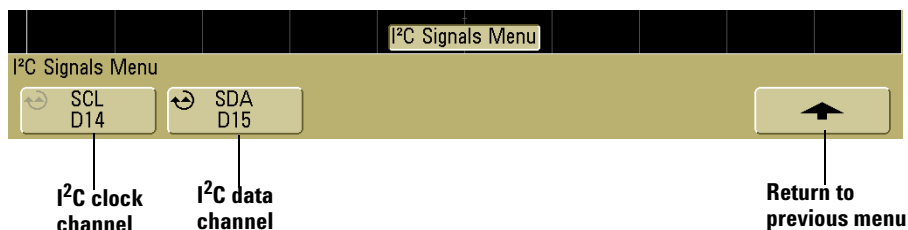

- b** Press the **SCL** softkey, and use the Entry knob to select the channel probing the clock signal.
 - c** Press the **SDA** softkey, and use the Entry knob to select the channel probing the data signal.
- 3** For the I²C signals, make sure the trigger or threshold levels are set to the middle of the signals:
 - For analog channels, turn the Trigger Level knob.
 - For digital channels, press the **D15 Thru D0** key and the **Thresholds** softkey to access the threshold level setting softkeys.
 - 4** If the decode line does not appear on the display, press the up-arrow softkey to return to the previous menu, then press the **Decode** softkey to turn it on.
 - 5** If the oscilloscope is stopped, press the **Run/Stop** key to acquire and decode data.

NOTE

If the setup does not produce a stable trigger, the I²C signal may be slow enough that the oscilloscope is AutoTriggering. Press the **Mode/Coupling** key, then press the **Mode** softkey to set the trigger mode from **Auto** to **Normal**.

You can use the **Delayed** horizontal sweep mode for easier navigation of the acquired data.

Interpreting Decoded I²C Data

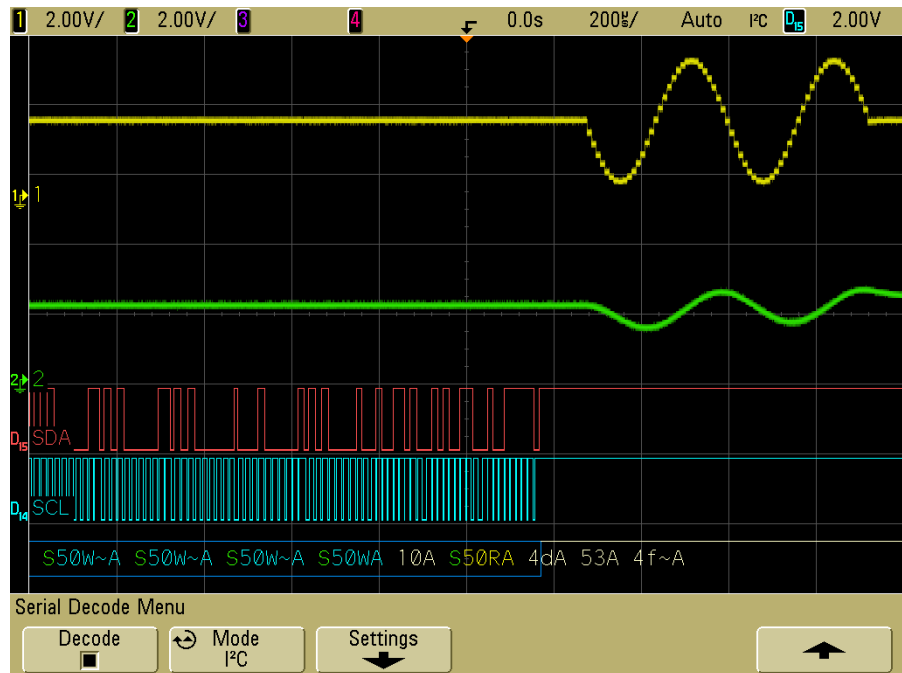

- White lines show an idle bus.
- Blue rectangles show an active bus (inside a packet/frame).
- In the decoded hexadecimal data:
 - Address values appear at the start of a frame.
 - Write addresses appear in light-blue along with the “W” character.
 - Read addresses appear in yellow along with the “R” character.
 - Restart addresses appear in green along with the “S” character.
 - Data values appear in white and may extend beyond the frame if an idle period follows.
 - “A” indicates Ack (low), “~A” indicates No Ack (high).
- Red dots in the decode line indicate that more data can be displayed. Scroll or expand the horizontal scale to view the data.
- Aliased bus values (undersampled or indeterminate) are drawn in red.
- Unknown bus values (undefined or error conditions) are drawn in red.

To decode SPI data

NOTE

Because of oscilloscope hardware resource limitations, you cannot decode SPI data while CAN or LIN triggering is selected.

NOTE

For SPI triggering setup see [page 132](#).

- 1 Select the SPI serial decode mode:
 - a Press the **Acquire** key.
 - b Press the **Serial Decode** softkey.

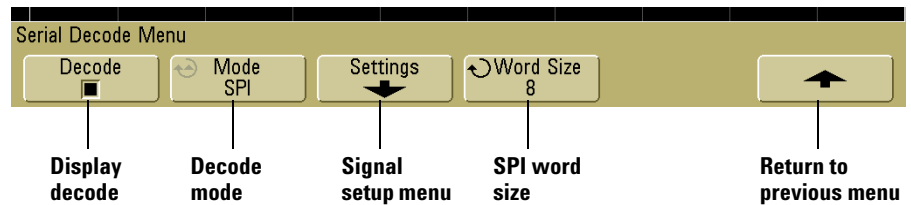

- c In the Serial Decode Menu, press the **Mode** softkey.
 - d Use the Entry knob (or repeatedly press and release the **Mode** softkey) to select the **SPI** serial decode mode.

2 Specify the SPI signals:

NOTE

If you have already set up an SPI trigger, the signals and their trigger or threshold levels have already been specified, and you can continue on with [step 4](#).

Changing SPI signals in the Serial Decode setup also changes them in the Trigger setup.

- a Press the **Settings** softkey to access the SPI Signals Menu.

The screenshot displays the SPI Signals Menu interface. At the top, a status bar shows channel numbers 1-4, a trigger icon, and settings: 0.0s, 2.00µs, Auto, SPI D₁₂, and TTL. The main area features a timing diagram with three signals: ~CS (active-low chip select), CLK (clock), and DATA. A vertical dashed line marks the 'Trigger Point' on the CLK signal. The DATA signal shows a sequence of bits: Bit 0, Bit 1, ..., Bit N-1, Bit N. Below the diagram is the 'SPI Signals Menu' with six buttons: 'Clock D11', 'Clock edge', 'Data D12', 'Frame by ~CS', '~CS D13', and 'Return to previous menu'. Labels at the bottom identify each button's function.

Currently selected Clock, Framing, or Data channel

Trigger level or threshold

SPI trigger

Graphic showing current state of the SPI signals setup

Data string trigger value

Clock signal

Clock edge

Data signal

Frame by option

Frame signal/value

Return to previous menu

- b** Press the **Clock** softkey, and use the Entry knob to select the channel probing the clock signal.
 - c** Press the rising or falling edge softkey to specify the edge that the clock occurs on.
 - d** Press the **Data** softkey, and use the Entry knob to select the channel probing the data signal.
 - e** Repeatedly press and release the **Frame by** softkey to select the method used to identify frames:
 - **~CS - Not Chip Select** – an active low chip select signal.
 - **CS - Chip Select** – an active high chip select signal.
 - **Clock Timeout** – clock idle for a period of time.
 - f** If you chose framing by chip select or not chip select, press the **CS** or **~CS** softkey, and use the Entry knob to select the channel probing the chip select signal.

If you chose framing by clock timeout, press the **Timeout** softkey, and use the Entry knob to specify the idle time.
- 3** For the SPI signals, make sure the trigger or threshold levels are set to the middle of the signals:
- For analog channels, turn the Trigger Level knob.
 - For digital channels, press the **D15 Thru D0** key and the **Thresholds** softkey to access the threshold level setting softkeys.
- 4** Press the up-arrow softkey to return to the previous menu. Press the **Word Size** softkey, and use the Entry knob to select the number of bits in a word.
- 5** If the decode line does not appear on the display, press the **Decode** softkey to turn it on.
- 6** If the oscilloscope is stopped, press the **Run/Stop** key to acquire and decode data.

NOTE

If the setup does not produce a stable trigger, the CAN signal may be slow enough that the oscilloscope is AutoTriggering. Press the **Mode/Coupling** key, then press the **Mode** softkey to set the trigger mode from **Auto** to **Normal**.

You can use the **Delayed** horizontal sweep mode for easier navigation of the acquired data.

Interpreting Decoded SPI Data

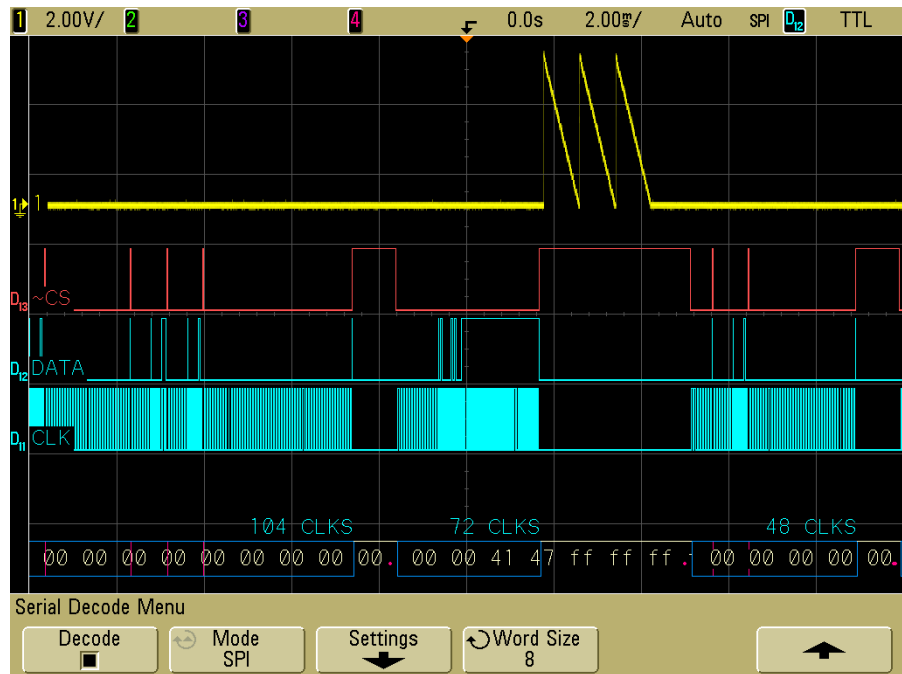

- White lines show an idle bus.
- Blue rectangles show an active bus (inside a packet/frame).
- The number of clocks in a frame appears in light-blue above the frame, to the right.
- Decoded hexadecimal data values appear in white and may extend beyond the frame if an idle period follows.
- Red dots in the decode line indicate that there is data that is not being displayed. Scroll or expand the horizontal scale to view the information.

- Aliased bus values (undersampled or indeterminate) are drawn in red.
- Unknown bus values (undefined or error conditions) are drawn in red.

To decode CAN data

NOTE

For CAN triggering setup see [page 107](#).

- 1 Connect the CAN signal to one of the oscilloscope's input channels.
- 2 Set up the trigger mode as described in “[Triggering the Oscilloscope](#)” on page 87. You can use CAN trigger or another trigger type.
- 3 Select the CAN serial decode mode:
 - a Press the **Acquire** key.
 - b Press the **Serial Decode** softkey.

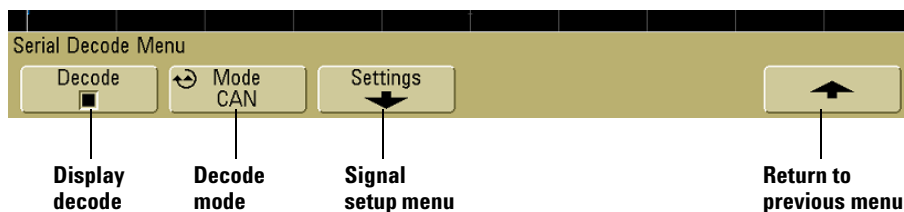

- c In the Serial Decode Menu, press the **Mode** softkey.
- d Use the Entry knob (or repeatedly press and release the **Mode** softkey) to select the **CAN** serial decode mode.

- 4 Specify the CAN signal:
 - a Press the **Settings** softkey to access the CAN Signals Menu.

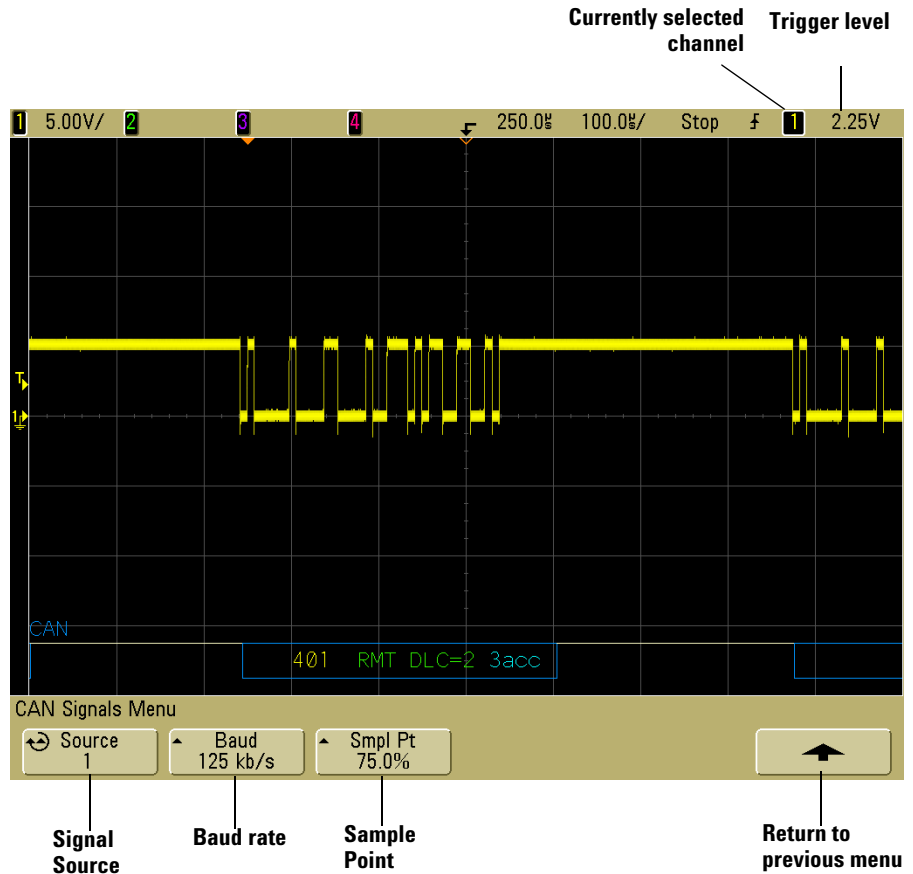

- 5 Press the **Source** softkey, and use the Entry knob to select the channel for the CAN signal. Make sure the trigger or threshold levels are set to the middle of the CAN signal.
- 6 Repeatedly press and release the **Baud** softkey to specify the CAN signal baud rate.
- 7 Repeatedly press and release the **Smpl Pt** softkey to select the point between phase segments 1 and 2 where the state of the

bus is measured. This controls the point within the bit's time where the bit value is captured.

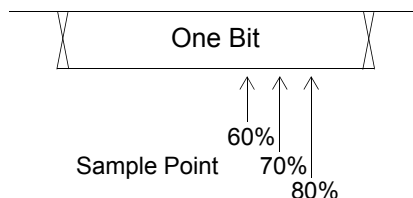

8 Set the trigger level.

- For analog channels, turn the Trigger Level knob.
- For digital channels, press the **D15 Thru D0** key and the **Thresholds** softkey to access the threshold level setting softkeys.

NOTE

Changing the Source settings in the Serial Decode setup also changes them in the Trigger setup.

9 Return to the previous menu by pressing the up-arrow softkey.

10 If the decode line does not appear on the display, press the **Decode** softkey to turn it on.

11 If the oscilloscope is stopped, press the **Run/Stop** key to acquire and decode data.

NOTE

If the setup does not produce a stable trigger, the CAN signal may be slow enough that the oscilloscope is AutoTriggering. Press the **Mode/Coupling** key, then press the **Mode** softkey to set the trigger mode from **Auto** to **Normal**.

You can use the **Delayed** horizontal sweep mode for easier navigation of the decoded data.

Interpreting Decoded CAN Data

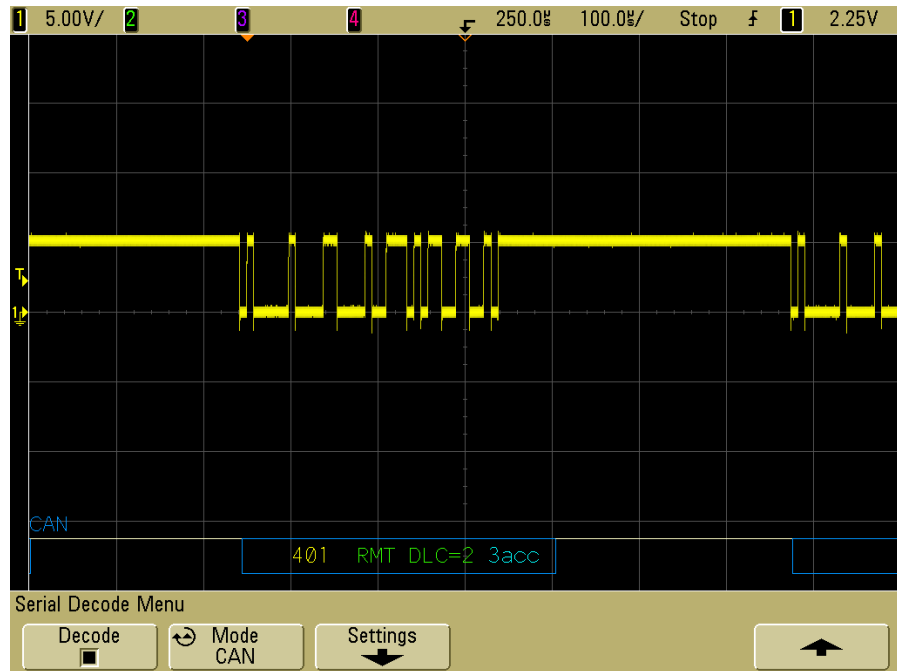

- Frame ID appears in hex digits in yellow. Frames of 11 or 29 bits are automatically detected.
- Remote frame (RMT) appears in green.
- Data length code (DLC) appears in blue.
- Data bytes appear in hex digits in white for data frames.
- Cyclic redundancy check (CRC) appears in hex digits in blue when valid, or in red to indicate that the oscilloscope's hardware decode calculated a CRC that is different from the incoming CRC data stream.
- White lines show an idle bus.
- Blue rectangles show an active bus (inside a packet/frame).
- Decoded hexadecimal data values may extend beyond the frame if the timebase setting is too slow.

- Red dots in the decode line indicate that there is data that is not being displayed. Scroll or expand the horizontal scale to view the information.
- Aliased bus values (undersampled or indeterminate) are drawn in red.
- Unknown bus values (undefined or error conditions) are drawn in red with a “?” label.
- Flagged error frames are drawn in red with an “ERR” label.

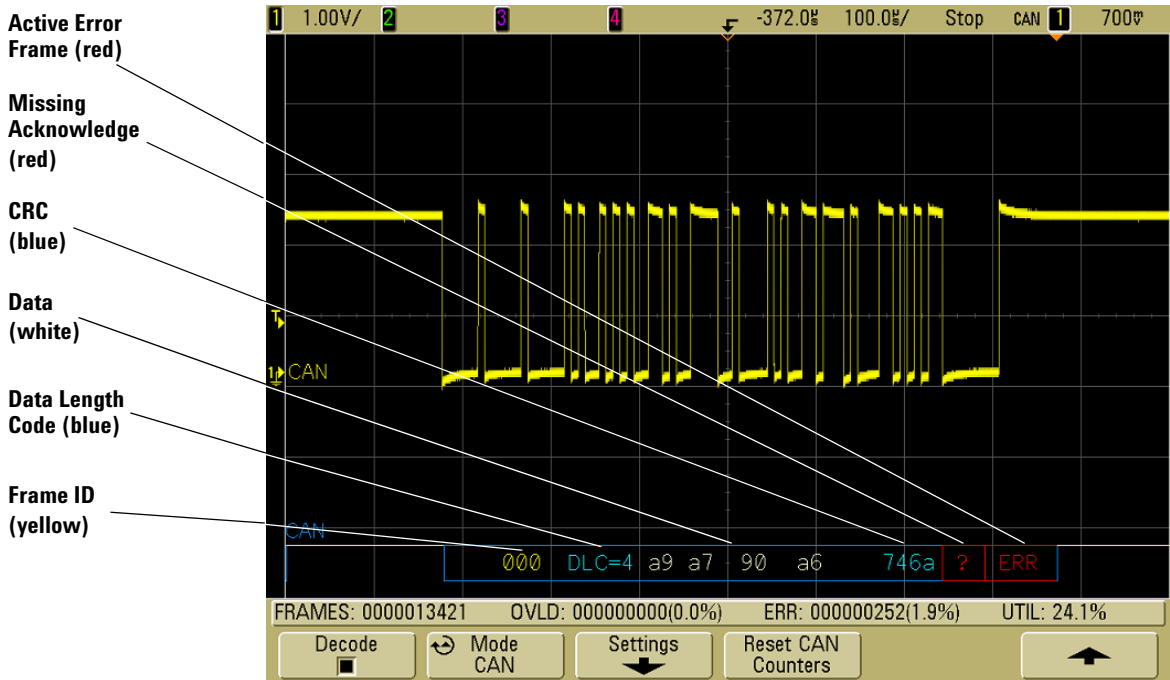

CAN Totalizer

The CAN totalizer provides a direct measure of bus quality and efficiency. The CAN totalizer measures total CAN frames, flagged error frames, overload frames, and bus utilization.

The totalizer is always running (counting frames and calculating percentages) and is displayed whenever CAN decode is displayed. The totalizer counts even when the oscilloscope is stopped (not acquiring data). Pressing the **Run/Stop** button does not affect the totalizer. When an overflow condition occurs, the counter displays **OVERFLOW**. The counters can be reset to zero by pressing the **Reset CAN Counters** softkey.

Types of Frames

- *Active error frames* are CAN frames in which a CAN node recognizes an error condition during a data or remote frame and issues an active error flag.
- A *partial frame* occurs when the oscilloscope detects any error condition during a frame that is not followed by an active error flag. Partial frames are not counted.

Counters

- The **FRAMES** counter gives the total number of completed remote, data, overload, and active error frames.
- The **OVL** counter gives the total number of completed overload frames and their percentage of the total number of frames.
- The **ERR** counter gives the total number of completed active error frames and their percentage of the total number of frames.
- The **UTIL** (bus load) indicator measures the percentage of time the bus is active. The calculation is done on 330 ms periods, approximately every 400 ms.

Example: If a data frame contains an active error flag, both the **FRAMES** counter and the **ERR** counter will be incremented. If a data frame contains an error that is not an active error it is considered a partial frame and no counters are incremented.

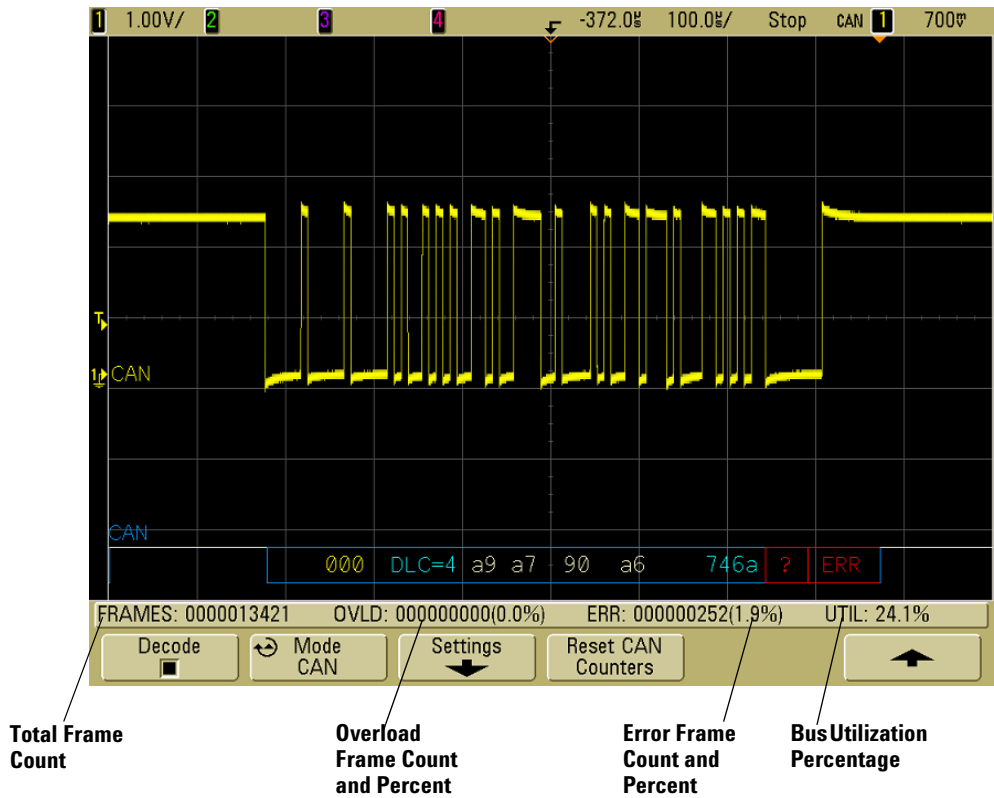

To decode LIN data

NOTE

For LIN triggering setup see [page 122](#).

- 1 Select the LIN serial decode mode:
 - a Press the **Acquire** key.
 - b Press the **Serial Decode** softkey.

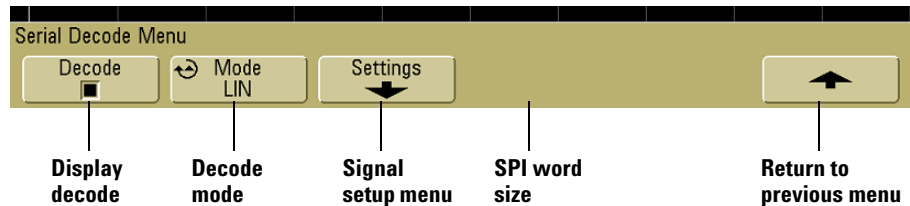

- c In the Serial Decode Menu, press the **Mode** softkey.
 - d Use the Entry knob (or repeatedly press and release the **Mode** softkey) to select the **LIN** serial decode mode.
- 2 Choose whether to include the parity bits in the identifier field.
 - a If you want to mask the upper two parity bits, ensure that the box under the **Show Parity** softkey is not selected.
 - b If you want to include the parity bits in the identifier field, ensure that the box under the **Show Parity** softkey is selected.

3 Specify the LIN signal:

- a Press the **Settings** softkey to access the LIN Signals Menu.

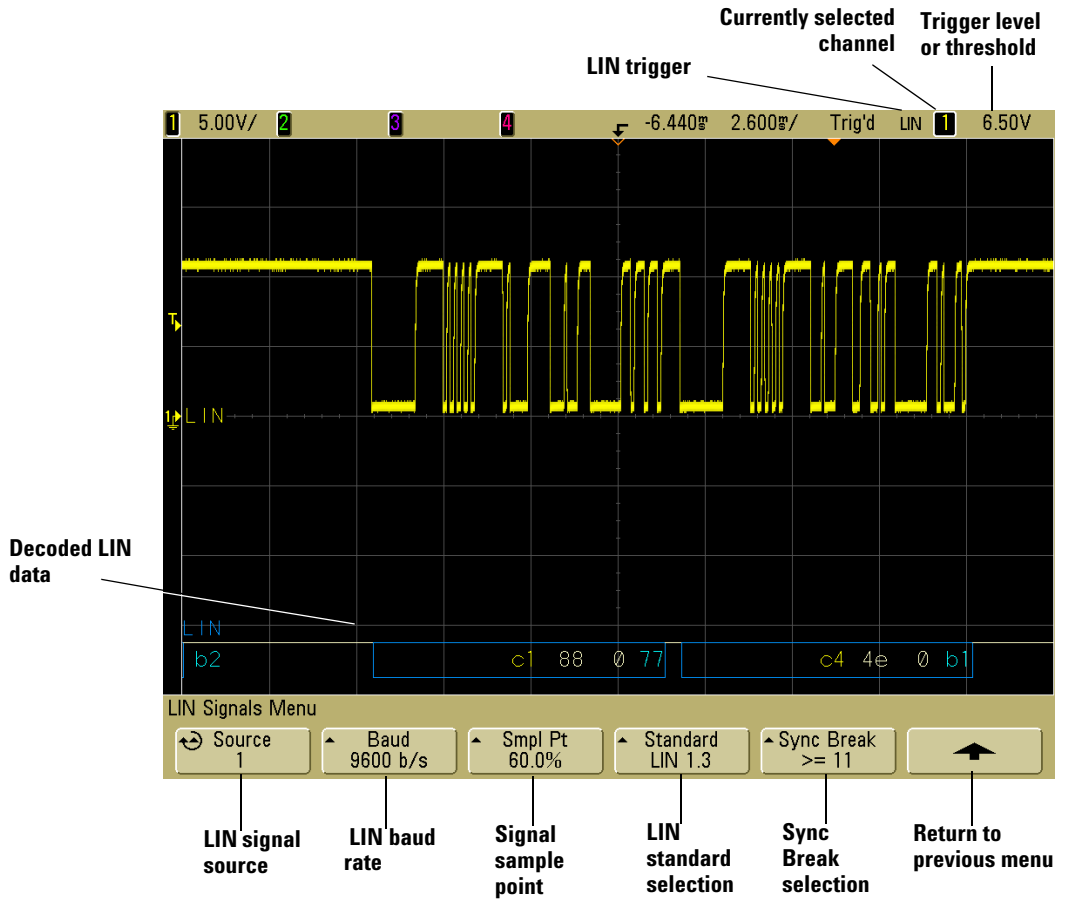

- b** Press the **Source** softkey, and use the Entry knob to select the channel probing the LIN signal.
- c** Repeatedly press and release the **Baud** softkey to specify the LIN signal baud rate.
- d** Repeatedly press and release the **Smpl Pt** softkey to select the sample point. This controls the point within the bit's time where the bit value is captured.

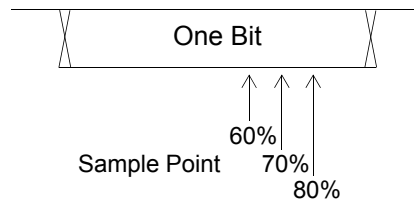

- e** Repeatedly press and release the **Standard** softkey to select the LIN standard (LIN 1.3 or LIN 2.0) of the measured signal. For LIN 1.2 signals, use the LIN 1.3 setting. The LIN 1.3 setting assumes the signal follows the “Table of Valid ID Values” as shown in section A.2 of the LIN Specification dated December 12, 2002. If your signal does not comply with the table, use the LIN 2.0 setting.
 - f** Repeatedly press and release the **Sync Break** softkey to define the minimum number of clocks that define a Sync Break.
- 4** Make sure the trigger or threshold levels are set to the middle of the LIN signal.
- For analog channels, turn the Trigger Level knob.
 - For digital channels, press the **D15 Thru D0** key and the **Thresholds** softkey to access the threshold level setting softkeys.

NOTE

Changing the Trigger settings in the Serial Decode setup also changes them in the Trigger setup.

- g** If the decode line does not appear on the display, press the up-arrow softkey to return to the previous menu, then press the **Decode** softkey.
- 5** If the oscilloscope is stopped, press the **Run/Stop** key to acquire and decode data.

NOTE

If the setup does not produce a stable trigger, the LIN signal may be slow enough that the oscilloscope is AutoTriggering. Press the **Mode/Coupling** key, then press the **Mode** softkey to set the trigger mode from **Auto** to **Normal**.

You can use the **Delayed** horizontal sweep mode for easier navigation of the decoded data.

Interpreting Decoded LIN Data

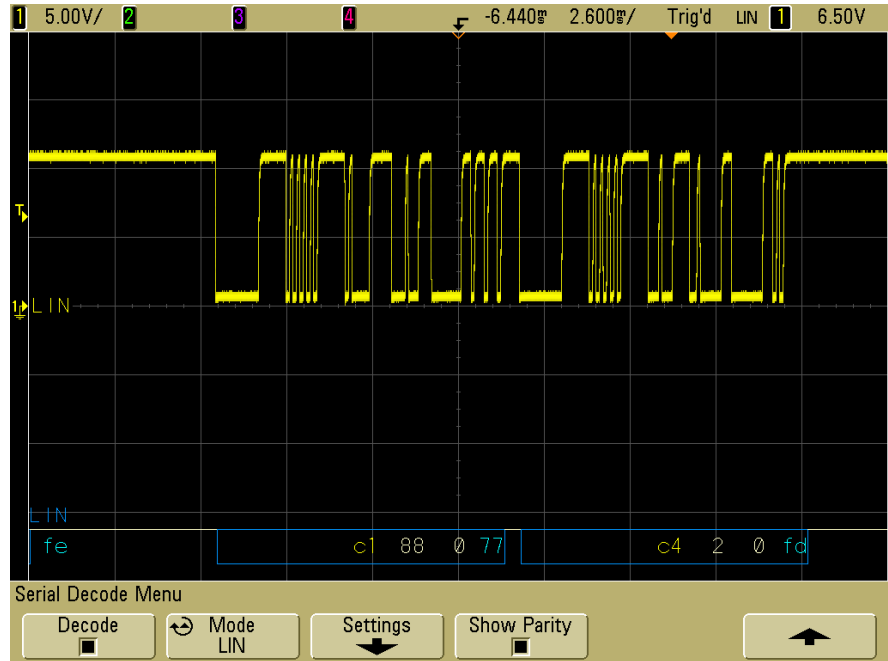

- White traces show an idle bus (LIN 1.3 only).
- Blue bi-level trace shows an active bus (inside a packet/frame).
- The hexadecimal ID and parity bits (if enabled) appear in yellow. If a parity error is detected the hexadecimal ID and parity bits (if enabled) appear in red.
- Decoded hexadecimal data values appear in white and may extend beyond the frame if an idle period follows.
- For LIN 1.3, the checksum appears in blue if correct, or red if incorrect. The checksum always appears in white for LIN 2.0.
- Red dots in the decode line indicate that there is data that is not being displayed. Scroll or expand the horizontal scale to view the information.
- Unknown bus values (undefined or error conditions) are drawn in red.
- If there is an error in the synch field, SYNC will appear in red.
- If the header exceeds the length specified in the standard, THM will appear red.
- If the total frame count exceeds the length specified in the standard, TFM will appear red (LIN 1.3 only).
- For LIN 1.3 a wakeup signal is indicated by WAKE in blue. If the wakeup signal is not followed by a valid wakeup delimiter a wakeup error is detected and displayed as WUP in red.

To reduce the random noise on a signal

If the signal you are probing is noisy, you can set up the oscilloscope to reduce the noise on the displayed waveform. First, you stabilize the displayed waveform by removing the noise from the trigger path. Second, you reduce the noise on the displayed waveform.

- 1 Connect a signal to the oscilloscope and obtain a stable display.
- 2 Remove the noise from the trigger path by turning on high-frequency rejection (HF reject), low-frequency rejection (LF reject), or noise rejection (see the following pages).
- 3 Use averaging (see [page 211](#)) to reduce noise on the displayed waveform.

HF Reject

High-frequency reject (HF reject) adds a low-pass filter with the 3-dB point at 50 kHz. HF reject removes high-frequency noise, such as AM or FM broadcast stations, from the trigger path.

- Press **Mode/Coupling** → **HF Reject**.

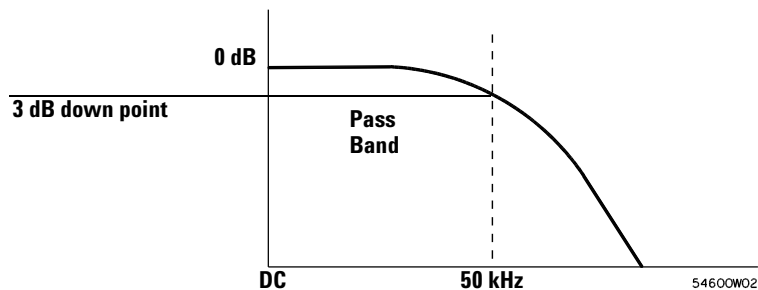

LF Reject

Low-frequency reject (LF reject) adds a high-pass filter with the 3-dB point at 50 kHz. LF reject removes low-frequency signals, such as power line noise, from the trigger path.

- Press **Mode/Coupling**→**Coupling**→**LF Reject**.

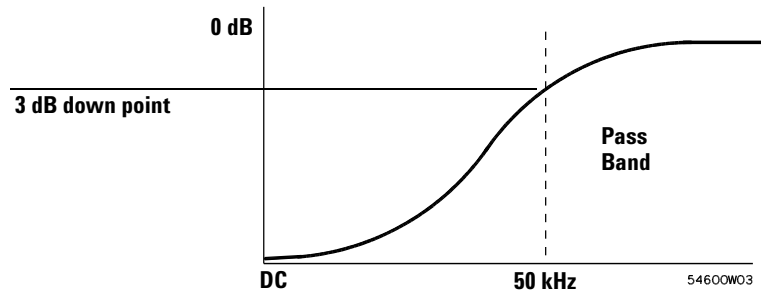

Noise rejection

Noise reject increases the trigger hysteresis band. By increasing the trigger hysteresis band, you reduce the possibility of triggering on noise. However, this also decreases the trigger sensitivity so that a slightly larger signal is required to trigger the oscilloscope.

- Press **Mode/Coupling**→**HF Reject**.

To capture glitches or narrow pulses with peak detect and infinite persistence

A glitch is a rapid change in the waveform that is usually narrow as compared to the waveform. Peak detect mode can be used to more easily view glitches or narrow pulses. In peak detect mode, narrow glitches and sharp edges are displayed more brightly than when in Normal acquire mode, making them easier to see.

To characterize the glitch, use the cursors or the automatic measurement capabilities of the oscilloscope.

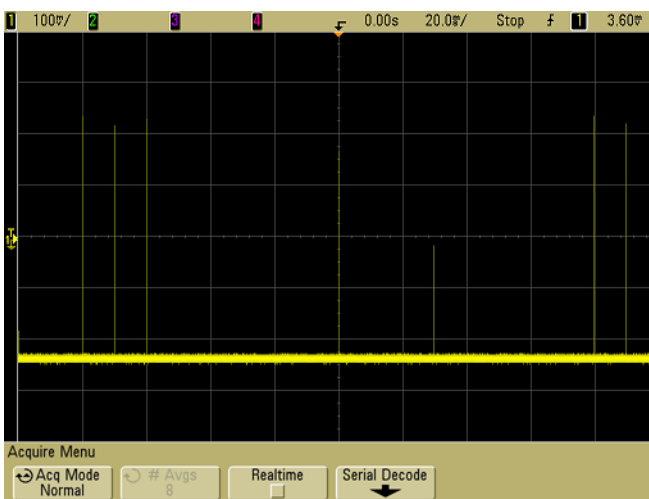

Figure 41 15 ns Narrow Pulse, 20 ns/div, Normal Mode

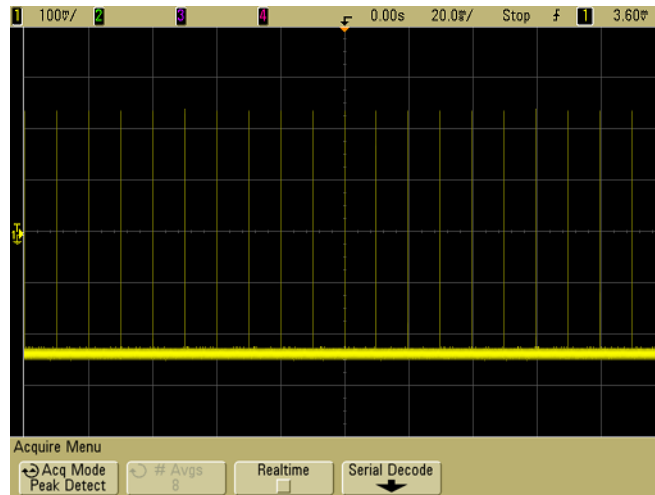

Figure 42 15 ns Narrow Pulse, 20 ms/div, Peak Detect Mode

Using peak detect mode to find a glitch

- 1 Connect a signal to the oscilloscope and obtain a stable display.
- 2 To find the glitch, press the **Acquire** key, then, press the **Acq Mode** softkey until **Peak Detect** is selected.
- 3 Press the **Display** key then press the ∞ **Persist** (infinite persistence) softkey.

Infinite persistence updates the display with new acquisitions but does not erase previous acquisitions. New sample points are shown at normal intensity while previous acquisitions are displayed in gray at lower intensity. Waveform persistence is not kept beyond the display area boundary.

Press the **Clear Display** softkey to erase previously acquired points. The display will accumulate points until ∞ **Persist** is turned off.

- 4 Characterize the glitch with delayed sweep:
 - a Press the **Main/Delayed** key, then press the **Delayed** softkey.
 - b To obtain a better resolution of the glitch, expand the time base.
 - c Use the horizontal delay time knob (◀▶) to pan through the waveform to set the expanded portion of the main sweep around the glitch.

How Autoscale Works

Autoscale automatically configures the oscilloscope to best display the input signal by analyzing any waveforms connected to the channel and external trigger inputs. This includes the digital channels on MSO models.

Autoscale finds, turns on, and scales any channel with a repetitive waveform that has a frequency of at least 50 Hz, a duty cycle greater than 0.5%, and an amplitude of at least 10 mV peak-to-peak. Any channels that do not meet these requirements are turned off.

The trigger source is selected by looking for the first valid waveform starting with external trigger, then continuing with the highest number analog channel down to the lowest number analog channel, and finally (if the oscilloscope is an MSO) the highest number digital channel.

During Autoscale, the delay is set to 0.0 seconds, the sweep speed setting is a function of the input signal (about 2 periods of the triggered signal on the screen), and the triggering mode is set to edge. Vectors remain in the state they were before the Autoscale.

Undo Autoscale

Press the **Undo Autoscale** softkey to return the oscilloscope to the settings that existed before you pressed the **Autoscale** key.

This is useful if you have unintentionally pressed the **Autoscale** key or do not like the settings Autoscale has selected and want to return to your previous settings.

Specifying the Channels Displayed After Autoscale

The **Channels** softkey selection determines which channels will be displayed on subsequent Autoscales.

- **All Channels** – The next time you press **Autoscale**, all channels that meet the requirements of Autoscale will be displayed.
- **Only Displayed Channels** – The next time you press **Autoscale**, only the channels that are turned on will be examined for signal activity. This is useful if you only want to view specific active channels after pressing **Autoscale**.

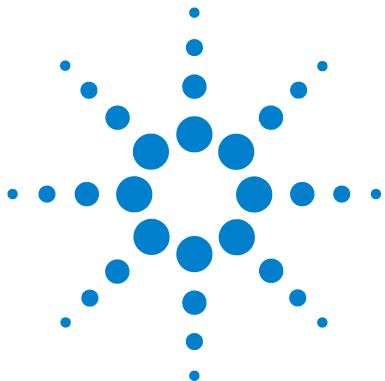

7 Saving and Printing Data

- To configure printing [246](#)
- To print the display to a file [250](#)
- To print the display to a USB printer [251](#)
- Supported printers [252](#)
- Secure Environment Mode Option [254](#)
- Saving and recalling traces and setups [255](#)
- To Autosave traces and setups [256](#)
- To save traces and setups to internal memory or to overwrite an existing USB mass storage device file [257](#)
- To save traces and setups to a new file on the USB mass storage device [258](#)
- To recall traces and setups [260](#)
- To use the file explorer [261](#)



To configure printing

You can print to a file or you can print to a USB printer. Use the **Print Config** menu to choose the type of image file you would like to create or to set up your printer.

You can print scale factors, print in color or grayscale, and choose whether to print each waveform on a separate sheet of paper (form feed). To conserve printer ink, you can invert the graticule colors so that the background is white instead of black.

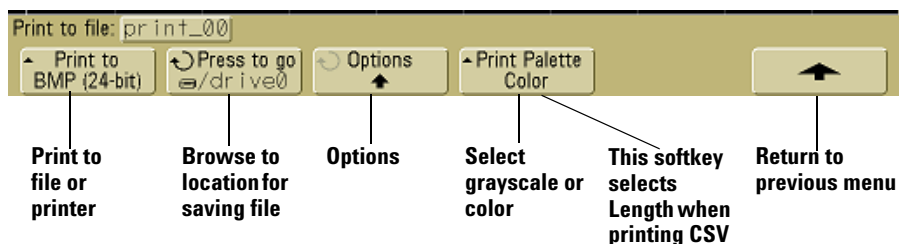

Selecting a print file format

To choose a file format, press **Utility**→**Print Config**→**Print to**. You can create an image file in one of the following file formats:

- **BMP (8-bit) image file** – The screen image is converted to a smaller, lower resolution bitmap file of the complete screen, including the status line and softkeys.
- **BMP (24-bit) image file** – This is a larger, high-resolution bitmap file of the complete screen, including the status line and softkeys.
- **PNG (24-bit) image file** – This is a high-resolution PNG format bitmap file of the complete screen, including the status line and softkeys.
- **CSV data file** – This creates a file of comma-separated variable values of displayed channels and math waveforms. This format is suitable for spreadsheet analysis.

- **ASCII XY data file** – Gives a separate file for each channel's output. For example: print_nn_channel1.csv. Maximum record length is obtained in single shot mode.
- **BIN data file** – Saves waveform data to a binary format file (see “Binary Data (.bin)” on page 277).

Length Control

The **Length** softkey appears when the CSV, ASCII XY, or BIN formats are selected. **Length** sets the number of data points that will be output to the file. **Length** can be set to 100, 250, 500, or 1000 when the acquisition is running or more when the acquisition is stopped. However, if serial decode is on, the full record length is always output.

Only displayed data points are output. Therefore, you need to adjust the Horizontal controls to display the data you want to save.

The Length control will perform a “1 of n” decimation of the data when necessary. For example: if the **Length** is set to 1000, and you are displaying a record that is 5000 data points in length, four of each five data points will be decimated, creating an output file 1000 data points in length.

Minimum and Maximum Values in CSV Files

If you are running a Quick Measurement Minimum or Maximum measurement, the minimum and maximum values shown in the Quick Measurement display may not appear in the CSV file.

Explanation:

When the oscilloscope's sample rate is 4 GSa/s, a sample will be taken every 250 ps. If the sweep speed is set to 100 ns/div, there will be 1000 ns of data displayed (because there are ten divisions across the screen). To find the total number of samples the oscilloscope will take:

$$1000ns \times 4Gsa/s = 4000samples$$

For measurement data, the oscilloscope will decimate the 4000 points to 1000 points that will fit on the display. This decimation will not lose track of the min and max values at each

of the 1000 horizontal data points, and min and max values will be displayed on screen. However, the oversampled data is also processed to provide a best-estimate value at each of the 1000 horizontal points. The data in the CSV file will be the best-estimate value at each of the 1000 horizontal points. Therefore, the min and max values may not appear in the CSV file.

This occurs when oversampling occurs
($10 \text{ * seconds per division * maximum sample rate} > 1000$).

NOTE

To save the CSV, ASCII XY, or BIN data, or BMP or PNG images to the USB storage device, it is necessary to press the **Quick Print** button (see [“To print the display”](#) on page 66).

Selecting print options

Press **Utility**→**Print Config**→**Options**.

- **Factors** – Select **Factors** if you want the oscilloscope scale factors to be included on your print. If you print to an image file, the scale factors will be sent to a separate file named `print_nn.txt`. If you print to a CSV file, the factors will be appended to the end of the file. Oscilloscope scale factors include vertical, horizontal, trigger, acquisition, math, and display settings.
- **Invert Graticule Colors** – The **Invert Graticule Colors** option can be used to reduce the amount of black ink it takes to print oscilloscope images by changing the black background to white.
- **Form Feed** – The **Form Feed** option can be selected to send a form feed command to the printer when the print is complete. Use this if you want only one print per sheet of paper. Switch **Form Feed** off when you want to put more than one print on a sheet of paper. The **Form Feed** option is grayed-out and unavailable when printing to a file.

Print Palette

- **Color**
- **Grayscale** – When **Grayscale** printing is selected, the traces are printed in shades of gray rather than in color. Grayscale printing is not applicable to CSV format.

To print the display to a file

- 1 To print to a file, connect a USB mass storage device to the USB port on the front or the rear of the oscilloscope.
- 2 Access the Print Config menu by pressing **Utility**→**Print Config**.
- 3 Choose a format using the **Print to** softkey.
- 4 Press the second softkey from the left and use the Entry knob to browse to a location where you would like to save the image file. You can select among connected USB mass storage devices, and you can choose a subdirectory if desired.
- 5 Press the **Quick Print** key on the front panel
- 6 To make subsequent printouts, simply press the **Quick Print** key.

NOTE

If two USB mass storage devices are connected to the oscilloscope, the first one is designated “drive0” and the second one is designated “drive5,” not “drive1.” This numbering method is normal; it is inherent in the USB driver.

To print the display to a USB printer

A USB printer can be connected to the oscilloscope through a USB host port on the front or rear of the oscilloscope. (The USB host ports are rectangular; the USB device port is square.) You need a USB cable to connect the printer.

- 1 Connect the printer to the USB port on either the front or the rear of the oscilloscope. A list of supported printers is given on [page 252](#).
- 2 To access the Print Config menu, press **Utility**→**Print Config**.
- 3 Press the **Print to** softkey and select the printer.

If the oscilloscope identifies the printer you have connected, the oscilloscope will choose the correct driver.

If the oscilloscope does not automatically choose the driver for your printer, use the **Driver** softkey and the Entry knob to select the correct driver for your printer. Choose **Generic** if you don't know which driver to use. Many printers that use PCL 3 printer control language will work with the oscilloscope.

- 4 Press the **Quick Print** key on the front panel.
- 5 To make subsequent printouts, simply press the **Quick Print** key.

Supported printers

At the time this manual was published, the following HP printers were supported. Other USB printers that use PCL 3 printer command language may also work with Agilent 6000 Series oscilloscopes.

Printers currently available in stores

Deskjet 350C
Deskjet 610C & 612C
Deskjet 630C & 632C
Deskjet 656
Deskjet 825
Deskjet 845C
Deskjet 648C
Deskjet 810C & 812C & 815C & 816C
Deskjet 842C
Deskjet 920
Deskjet 932C & 935C
Deskjet 940 & 948
Deskjet 952C
Deskjet 960
Deskjet 970C
Deskjet 980
Deskjet 990C
Deskjet 995
Deskjet 1220C & 1125C
Deskjet 3816 & 3820
Deskjet 5550 & 5551
Deskjet 6122 & 6127
Deskjet 5600 & 5100 & 5800
Deskjet CP1160 & CP1700
Deskjet 9300 & 9600
Deskjet PhotoSmart PS100 & PS130 & PS230 & PS140 & PS240 & 1000 & 1100
Deskjet PhotoSmart P2500 & P2600
Deskjet PhotoSmart PS1115 & PS1215 & PS12818 & PS1315
Deskjet PhotoSmart PS7150 & PS7350 & PS7550
Deskjet PhotoSmart PS7960 & PS7760 & PS7660 & PS7260 & PS7268
Deskjet PSC 2100 & 2150 & 2200 & 2300 & 2400 & 2500 & 2170
Officejet 5100 & 6100 & 6150 & 7100 & 9100
Apollo P2100 & P2150
Apollo P2200 & P2250

E-Printer e20
Business InkJet 2200 & 2230 & 2250 & 2280 & 3000 & 1100 & 2300

Legacy Printers

Deskjet 600
Deskjet 640 & 642 & 644
Deskjet 660C
Deskjet 670 & 670TV & 672TV & 672C
Deskjet 680C & 682C
Deskjet 690C & 692C & 693C & 694C & 695C & 697C
Deskjet 830C & 832C
Deskjet 840C & 843
Deskjet 880 & 882C
Deskjet 895C
Deskjet 930C
Deskjet 950C & 955 & 957
Deskjet 975C

Secure Environment Mode Option

Secure environment mode is compliant to National Industrial Security Program Operating Manual (NISPOM) Chapter 8 requirements.

Secure environment mode is called option SEC when it is ordered with the oscilloscope. When adding secure environment mode after oscilloscope purchase, the option is called model N5427A, and the oscilloscope must be returned to an Agilent service center for installation.

When secure environment mode is installed, trace and setup data are stored to internal volatile memory (rather than internal non-volatile memory). Oscilloscope setup, waveform, and trace data are erased when the power is shut off. This ensures that any setup, waveform, and trace data will not be visible to the next user upon power-up. The clock, LAN, and GPIB settings are not discarded upon power-down.

To permanently store data, you can save it to an external device through one of the oscilloscope's USB ports.

Once installed, secure environment mode can not be disabled. Secure environment mode is available beginning with system software version 3.50. As a precaution against attempting to defeat secure environment mode, this option prevents older software from being installed.

When installed, the secure environment mode license will appear as SEC in the Installed Licenses line of the "About Oscilloscope" display. To access the About Oscilloscope display, press the **Utility** key, then press the **Service** softkey, then press the **About Oscilloscope** softkey.

Saving and recalling traces and setups

You can save the oscilloscope's current setup and waveform trace to the oscilloscope's internal memory. In 6000 Series oscilloscopes that do not have the Secure Environment Mode option the data are stored to non-volatile memory. In 6000 Series oscilloscopes that are equipped with Secure Environment mode the data are stored to volatile memory.

In all 6000 Series oscilloscopes, you can save the setup and waveform trace to a USB mass storage device (for example, a USB flash drive), then recall the setup, waveform trace, or both later.

When you save a setup, all settings including measurements, cursors, math functions, and horizontal, vertical, and trigger settings are saved to the file you have selected.

Saving a trace lets you save the visible portion of the acquisition (the displayed waveform) for later recall and comparison with other measurements. Recalled traces appear on the display in blue.

The normal application for a recalled trace is a quick comparison of measurement results. For example, you might make a measurement on a known good system, save the result in internal memory or to a USB mass storage device, then make the same measurement on a test system and recall trace to see the differences.

- Press the **Save/Recall** key to display the Save/Recall menu.

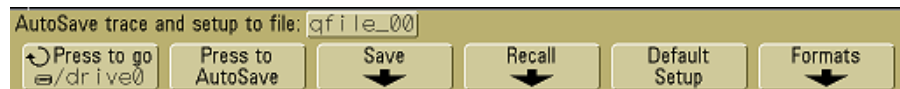

To Autosave traces and setups

- 1 Connect a signal to the oscilloscope and obtain a stable display.
- 2 Connect a USB mass storage device to the USB port on the front panel or the rear panel.

NOTE

Regarding USB Ports:

The USB port on the front panel and the USB port on the rear panel labeled "HOST" are USB Series A receptacles. These are the receptacles to which you can connect USB mass storage devices and printers.

The square receptacle on the rear panel labeled "DEVICE" is provided for controlling the oscilloscope over USB. See the *6000 Series Oscilloscopes Programmer's Quick Start Guide* or the *6000 Series Oscilloscopes Programmer's Reference* for more information. To access these documents online, point your web browser to www.agilent.com/find/mso6000 and select Library.

If two USB mass storage devices are connected to the oscilloscope, the first one is designated "drive0" and the second one is designated "drive5," not "drive1." This numbering method is normal; it is inherent in the USB driver.

- 3 Press the **Save/Recall** key.
- 4 Turn the Entry knob and then press the far left softkey to select a directory on a USB mass storage device.
- 5 Press the **Press to Autosave** softkey.

Your current setup and waveform trace will be saved to files using automatically generated file names (**QFILE_nn**) on the USB mass storage device. The file name is shown in the line above the softkeys.

The **nn** number in the **QFILE_nn** file name will automatically increment (starting at 00) each time you save a new file to the USB mass storage device.

When viewed from the File Explorer Menu (**Utility**→**File Explorer**) the trace file will have a **TRC** file extension and the setup file will have a **SCP** file extension.

To save traces and setups to internal memory or to overwrite an existing USB mass storage device file

- 1 If you will be saving a trace and/or setup to a USB mass storage device, connect the device to the oscilloscope.
- 2 Press the **Save/Recall** key.
- 3 Press the **Save** softkey to display the Save menu.



- 4 Turn the Entry knob and press the far left softkey to select an internal memory file or USB mass storage device file to be overwritten.

In the following screen image:

- **drive0** is a USB mass storage device which has been connected to the oscilloscope.
- **C:** is the root directory of the oscilloscope's internal memory.
- **intern0** through **intern9** are the internal nonvolatile memory locations that can be used for storing setups and traces.
- Use the **<up>** selection to move up one level in the directory structure.

You cannot create new file names in the oscilloscope's internal memory, you can only overwrite the existing files.

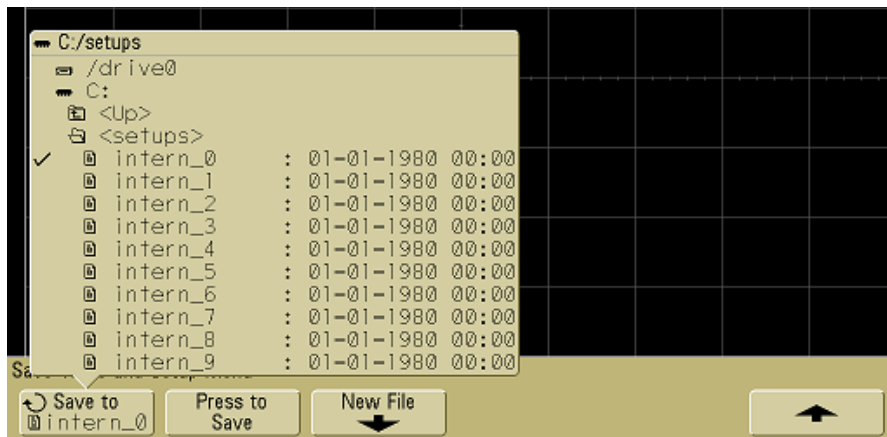

- 5 When you have selected the file name to be overwritten, press the **Press to Save** softkey to save your current setup and waveform trace to the file.

To save traces and setups to a new file on the USB mass storage device

- 1 Follow steps 1-3 in the procedure on [page 257](#).
- 2 Turn the Entry knob and press the far left softkey to select a directory on a USB mass storage.
- 3 To create a new file name, press the **New File** softkey.



New file names can only be written to a USB mass storage device, not the internal memory.

- 4 Turn the Entry knob to select the first character in the file name.

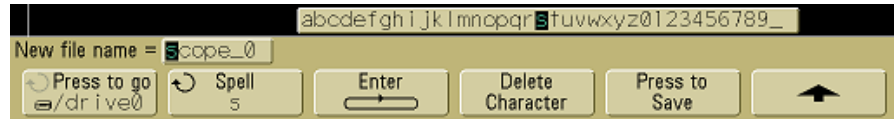

Turning the Entry knob selects a character to enter into the highlighted position shown in the “**New file name =**” line above the softkeys and in the **Spell** softkey.

- 5 Press the **Enter** softkey to enter the selected character and go to the next character position.

You may position the highlight on any character in the file name by successively pressing the **Enter** softkey.

- 6 To delete a character from the file name, press the **Enter** softkey until the letter you want to delete is highlighted, then press the **Delete Character** softkey.
- 7 When you are done entering characters for the file name, press the **Press to Save** softkey to save the file.

Two files will be saved to the USB mass storage device. In the example above, **SCOPE1.TRC** will be the trace file and **SCOPE1.SCP** will be the setup file. You do not need to remember these file extensions because you can select trace, setup, or both when you recall this information using the Recall menu.

To recall traces and setups

- 1 If you will be recalling a trace and/or setup from a USB mass storage device, connect the device to the oscilloscope.
- 2 Press the **Save/Recall** key to display the Save/Recall menu.
- 3 Press the **Recall** softkey to display the Recall menu.



- 4 Press the **Recall:** softkey and select the type of information to recall.

You can recall a waveform **Trace**, an oscilloscope **Setup**, or **Trace and Setup**.

NOTE

Be sure to recall both setup and trace if you want to measure the recalled trace with cursors.

- 5 Select the directory and choose a file to recall by turning the Entry knob and pressing the associated softkey.

INTERN_n are internal nonvolatile oscilloscope memory files. All other files in the list are stored on the USB mass storage device.

NOTE

Recalling overwrites current settings

Because recalling a setup will overwrite the oscilloscope's current settings, you may want to save the existing setup first.

- 6 Recall the selected file by pressing the **Press to Recall** softkey.
- 7 The recalled trace will be displayed in blue.
- 8 To clear the display of any recalled trace, press **Display**→**Clear Display**.

To use the file explorer

The File Explorer menu lets you load or delete files from a USB mass storage device.

- 1 Connect a USB mass storage device to the USB port on the front or the rear of the oscilloscope. A small colored circle icon will be displayed as the USB device is read.
- 2 Press **Utility**→**File Explorer**.
- 3 Press the far left softkey and turn the Entry knob to select the USB mass storage device, and a directory and file on the USB mass storage device.

You can create directories on a USB mass storage device using your PC or other instrument. You can navigate to any directory that you have made using the Entry knob and the far left softkey.

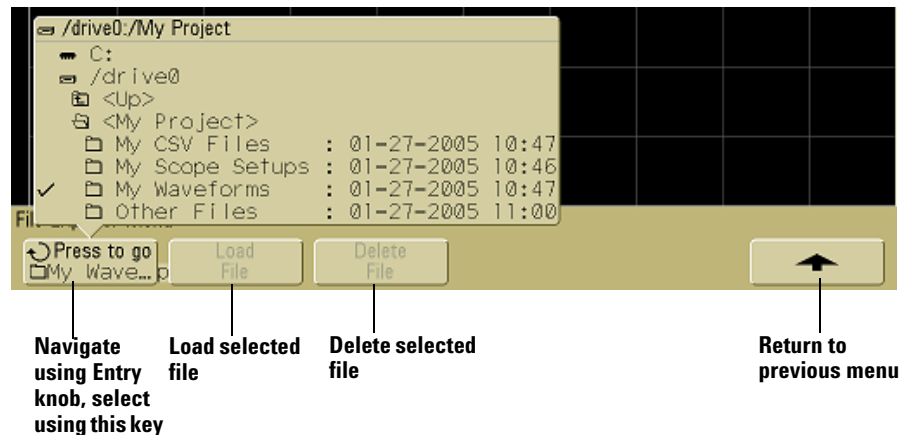

NOTE

If two USB mass storage devices are connected to the oscilloscope, the first one is designated "drive0" and the second one is designated "drive5," not "drive1." This numbering method is normal; it is inherent in the USB driver.

4 To load a file into the oscilloscope press the **Load File** softkey.

Files that can be loaded into the oscilloscope:

- **QFILE_nn.SCP** setup files, **QFILE_nn.TRC** trace files, and other user-defined setup or trace files that were created using the **Save/Recall** key on the front panel of the oscilloscope.
- Localized language pack files (**LANGPACK.JZP**).
- System software files (***.BIN** and ***.JZP**).

Files that cannot be loaded into the oscilloscope:

- Any **PRINT_nn.xxx** printer file.
- Any other file not created by the oscilloscope.

5 To delete a file from the USB mass storage device, press the **Delete File** softkey.

NOTE

Deleted files cannot be recovered

A file that has been deleted from the USB mass storage device cannot be recovered by the oscilloscope.



8 Reference

- Upgrading to an MSO or adding memory depth [264](#)
- Software and firmware updates [264](#)
 - To set up the I/O port [265](#)
 - To use the web interface [265](#)
- Using the 10 MHz reference clock [267](#)
 - To supply a sample clock to the oscilloscope [267](#)
- To synchronize the timebase of two or more instruments [269](#)
- To check warranty and extended services status [269](#)
- To return the instrument [270](#)
- To clean the oscilloscope [270](#)
- Digital channel signal fidelity: Probe impedance and grounding [271](#)
 - To replace digital probe leads [276](#)
- Binary Data (.bin) [277](#)



Upgrading to an MSO or adding memory depth

A license can be installed to activate the digital channels of an oscilloscope that was not originally ordered as a mixed-signal oscilloscope (MSO). A mixed signal oscilloscope has analog channels plus 16 time-correlated digital timing channels.

A license can also be installed to increase the memory depth of an oscilloscope that was not originally ordered with the maximum memory depth available.

To view the currently installed licenses press
Utility→**Options**→**Features**→**Show license information**.

For information about upgrading your oscilloscope through licensing, contact your local Agilent Technologies representative or see www.agilent.com/find/mso6000.

Software and firmware updates

From time to time Agilent Technologies releases software and firmware updates for its products. To search for firmware updates for your oscilloscope, point your web browser to www.agilent.com/find/mso6000 and select **Technical Support**, then select **Software Downloads & Utilities**.

To view the currently installed software and firmware press
Utility→**Service**→**About Oscilloscope**.

To set up the I/O port

The oscilloscope can be controlled via GPIB, LAN, or USB.

The oscilloscope's I/O configuration, including its IP address and hostname, can be viewed by pressing **Utility**→**I/O**.

To change the I/O controller settings, press the **Configure** softkey, and choose the I/O connection type (GPIB, LAN, or USB).

For instructions on setting up the oscilloscope to run from a controller via LAN, GPIB, or USB, see the *Agilent 6000 Series Oscilloscopes Programmer's Quick Start Guide*.

To use the web interface

To access the oscilloscope using the web interface:

- 1 Connect the oscilloscope to your network.
- 2 In the web browser on a remote computer, type the oscilloscope's IP address or host name into your web browser (for example, <http://130.29.69.36/> or <http://hostname.company.com/>).

You can find the oscilloscope's IP address and host name information by pressing the oscilloscope's **Utility** key and then pressing the **I/O** softkey.

Support | Products | Agilent Site

Agilent Technologies Oscilloscope

Another web-enabled instrument from Agilent Technologies

Welcome to your **Web-Enabled Oscilloscope**

Information about this Web-Enabled Instrument

Instrument:	DSO6104A Oscilloscope
Serial Number:	30d3090505
Description:	Agilent DSO6104A (30d3090505)
Hostname:	panther19.cos.agilent.com
IP Address:	130.29.68.219
VISA TCP/IP Connect String:	TCPIP0::panther19::INSTR

Advanced information

Use the navigation bar on the left to access your Oscilloscope and related information.

© Agilent Technologies, Inc. 2005

In the oscilloscope's web interface, you can:

- View information about the oscilloscope like its model number, serial number, host name, IP address, and VISA connect string.
- View oscilloscope firmware version information and upload new firmware into the oscilloscope.
- View and modify the oscilloscope's network configuration parameters.
- View the oscilloscope's network status information.

Using the 10 MHz reference clock

The **10 MHz REF** BNC connector on the rear panel is provided so you can:

- Supply a more accurate sample clock signal to the oscilloscope, or
- Synchronize the timebase of two or more instruments.

Sample clock and frequency counter accuracy

The oscilloscope's timebase uses a built-in reference that has an accuracy of 15 ppm. This is sufficient for most uses. However, if you are looking at a window that is very narrow compared to the selected delay (for example, looking at a 15 ns pulse with the delay set to 1 ms), significant error can be introduced.

Using the built-in sample clock, the oscilloscope's hardware frequency counter is a 5-digit counter.

Supplying an external timebase reference

When you supply an external timebase reference, the hardware frequency counter is automatically changed to an 8-digit counter. In this case, the frequency counter (**Quick Meas**→**Select**→**Counter**) is as accurate as the external clock.

For more information on the hardware frequency counter, see [“Counter”](#) on page 187.

To supply a sample clock to the oscilloscope

- 1 Connect a 10 MHz square or sine wave to the BNC connector labeled **10 MHz REF**. The amplitude must be between 180 mV and 1 V, with an offset of between 0 V and 2 V.



CAUTION

Do not apply more than ± 15 V at the 10 MHz REF BNC connector on the rear panel or damage to the instrument may occur.

2 Press **Utility**→**Options**→**Rear Panel**→**Ref Signal**.

3 Use the Entry Knob and the **Ref Signal** softkey to select **10 MHz input**.

A black locked padlock icon will appear at the top of the display.

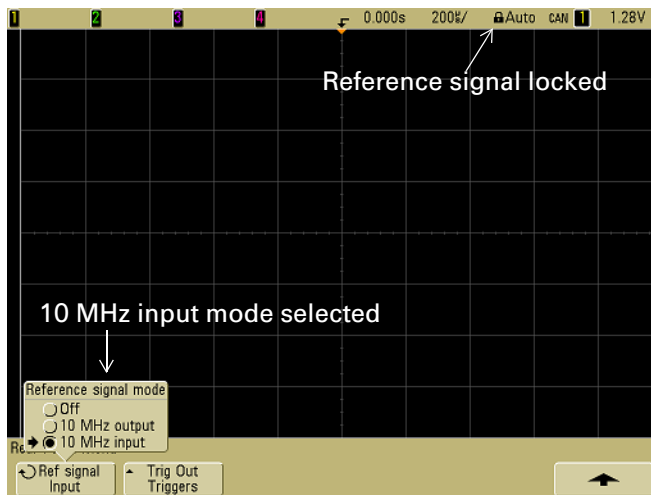

If the externally supplied sample clock varies greater than 0.5% from 10 MHz a soft unlock will occur. The oscilloscope will continue to acquire data but the lock symbol in the upper right part of the display will become a red unlocked padlock icon.

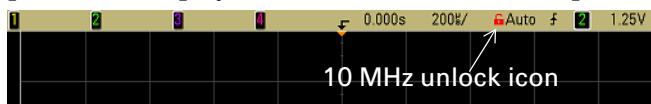

If the externally supplied sample clock signal is lost, a hard unlock will occur. The lock symbol in the upper right part of the display will become a red unlocked padlock icon and the oscilloscope will stop acquiring data. The oscilloscope will resume sampling when the externally supplied sample clock becomes stable again.



To synchronize the timebase of two or more instruments

The oscilloscope can output its 10 MHz system clock for the purpose of synchronization with other instruments.

- 1 Connect a BNC cable to the BNC connector labeled **10 MHz REF** on the rear panel of the oscilloscope.
- 2 Connect the other end of the BNC cable to the instrument(s) that will accept the 10 MHz reference signal. Put a 50 Ω termination at the input to the other instrument to terminate the signal.
- 3 Press **Utility**→**Options**→**Rear Panel**→**Ref Signal**.
- 4 Use the Entry Knob and the **Ref Signal** softkey to select **10 MHz output**.

The oscilloscope will output its 10 MHz reference signal at TTL levels.

To check warranty and extended services status

To learn the warranty status of your oscilloscope:

- 1 Point your web browser to:
www.agilent.com/find/warrantystatus
- 2 Enter your product's model number and serial number. The system will search for the warranty status of your product and display the results. If the system cannot find your product's warranty status, select **Contact Us** and speak with an Agilent Technologies representative.

To return the instrument

Before shipping the oscilloscope to Agilent Technologies, contact your nearest Agilent Technologies sales or service office for additional details. Information on contacting Agilent Technologies can be found at www.agilent.com/find/contactus.

1 Write the following information on a tag and attach it to the oscilloscope.

- Name and address of owner
- Model number
- Serial number
- Description of service required or failure indication

2 Remove accessories from the oscilloscope.

Only return accessories to Agilent Technologies if they are associated with the failure symptoms.

3 Package the oscilloscope.

You can use the original shipping container, or provide your own materials sufficient to protect the instrument during shipping.

4 Seal the shipping container securely, and mark it FRAGILE.

To clean the oscilloscope

1 Remove power from the instrument.

2 Clean the external surfaces of the oscilloscope with a soft cloth dampened with a mixture of mild detergent and water.

3 Make sure that the instrument is completely dry before reconnecting it to a power source.

Digital channel signal fidelity: Probe impedance and grounding

You may encounter problems when using the mixed-signal oscilloscope that are related to probing. These problems fall into two categories: probe loading and probe grounding. Probe loading problems generally affect the circuit under test, while probe grounding problems affect the accuracy of the data to the measurement instrument. The design of the probes minimizes the first problem, while the second is easily addressed by good probing practices.

Input Impedance

The logic probes are passive probes, which offer high input impedance and high bandwidths. They usually provide some attenuation of the signal to the oscilloscope, typically 20 dB.

Passive probe input impedance is generally specified in terms of a parallel capacitance and resistance. The resistance is the sum of the tip resistor value and the input resistance of the test instrument (see the following figure). The capacitance is the series combination of the tip compensating capacitor and the cable, plus instrument capacitance in parallel with the stray tip capacitance to ground. While this results in an input impedance specification that is an accurate model for DC and low frequencies, the high-frequency model of the probe input is more useful (see the following figure). This high-frequency model takes into account pure tip capacitance to ground as well as series tip resistance, and the cable's characteristic impedance (Z_0).

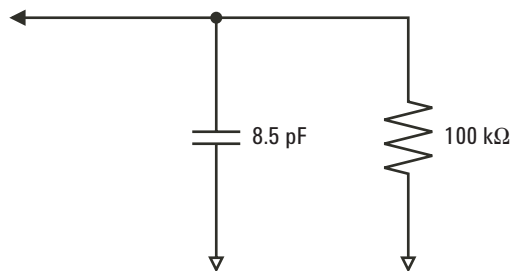

Figure 43 DC and Low-Frequency Probe Equivalent Circuit

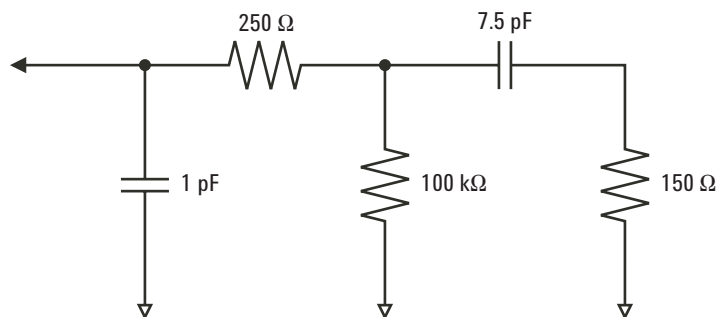

Figure 44 High-Frequency Probe Equivalent Circuit

The impedance plots for the two models are shown in these figures. By comparing the two plots, you can see that both the series tip resistor and the cable's characteristic impedance extend the input impedance significantly. The stray tip capacitance, which is generally small (1 pF), sets the final break point on the impedance chart.

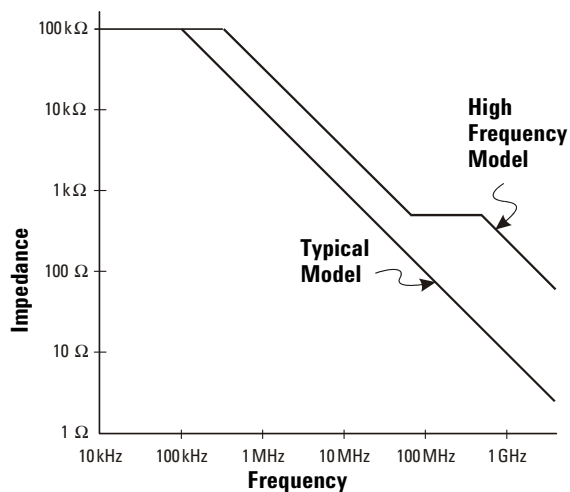

Figure 45 Impedance versus Frequency for Both Probe Circuit Models

The logic probes are represented by the high-frequency circuit model shown above. They are designed to provide as much series tip resistance as possible. Stray tip capacitance to ground is minimized by the proper mechanical design of the probe tip assembly. This provides the maximum input impedance at high frequencies.

Probe Grounding

A probe ground is the low-impedance path for current to return to the source from the probe. Increased length in this path will, at high frequencies, create large common mode voltages at the probe input. The voltage generated behaves as if this path were an inductor according to the equation:

$$V = L \frac{di}{dt}$$

Increasing the ground inductance (L), increasing the current (di) or decreasing the transition time (dt), will all result in increasing the voltage (V). When this voltage exceeds the threshold voltage defined in the oscilloscope, a false data measurement will occur.

Sharing one probe ground with many probes forces all the current that flows into each probe to return through the same common ground inductance of the probe whose ground return is used. The result is increased current (di) in the above equation, and, depending on the transition time (dt), the common mode voltage may increase to a level that causes false data generation.

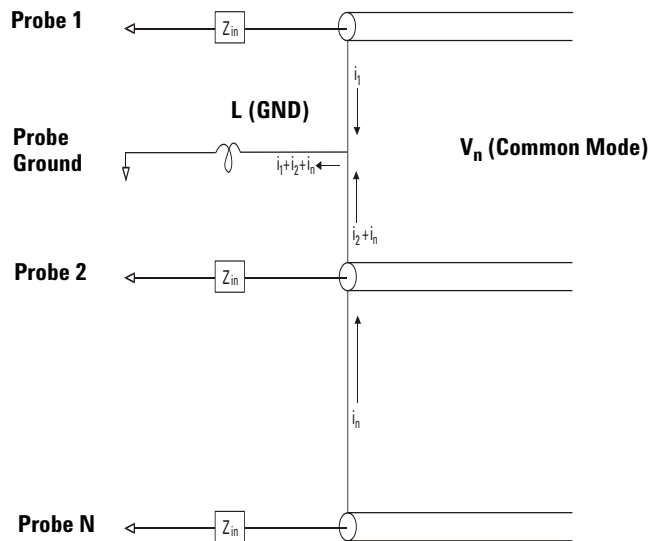

Figure 46 Common Mode Input Voltage Model

In addition to the common mode voltage, longer ground returns also degrade the pulse fidelity of the probe system. Rise time is increased, and ringing, due to the undamped LC circuit at the input of the probe, is also increased. Because the digital channels display reconstructed waveforms, they do not show ringing and perturbations. You will not find ground problems through examination of the waveform display. In fact, it is likely you will discover the problem through random glitches or inconsistent data measurements. Use the analog channels to view ringing and perturbations.

Best Probing Practices

Because of the variables L , di , and dt , you may be unsure how much margin is available in your measurement setup. The following are guidelines for good probing practices:

- The ground lead from each digital channel group (D15–D8 and D7–D0) should be attached to the ground of the circuit under test if any channel within the group is being used for data capture.
- When capturing data in a noisy environment, every third digital channel probe's ground should be used in addition to the channel group's ground.
- High-speed timing measurements (rise time < 3 ns) should make use of each digital channel probe's own ground.

When designing a high-speed digital system, you should consider designing dedicated test ports that interface directly to the instrument's probe system. This will ease measurement setup and ensure a repeatable method for obtaining test data. The 01650-61607 16-channel logic probe and termination adapter is designed to make it easy to connect to industry-standard, 20-pin board connectors. This probe consists of a 2 m logic analyzer probe cable and a 01650-63203 termination adapter that provides the proper RC networks in a very convenient package. Three 20-pin, low-profile, straight board connectors are included. Additional board connectors can be ordered from Agilent Technologies.

To replace digital probe leads

If you need to remove a probe lead from the cable, insert a paper clip or other small pointed object into the side of the cable assembly, and push to release the latch while pulling out the probe lead.

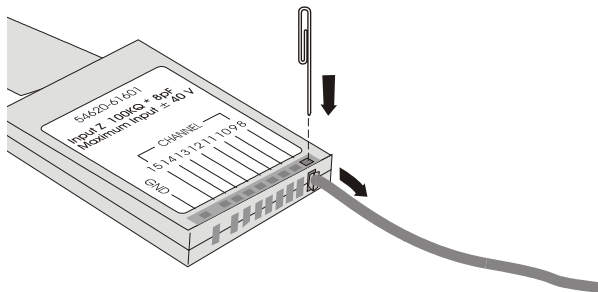

Table 13 Digital Probe Replacement Parts

Part Number	Description
54620-68701	Digital probe kit
5959-9333	Replacement probe leads (qty 5)
5959-9335	Replacement 2-inch probe ground lead (qty 5)
01650-94309	Package of probe labels
54620-61801	16-channel cable (qty 1)
5090-4833	Grabbers (qty 20)

For other replacement parts, consult the *6000 Series Oscilloscope Service Guide*.

Binary Data (.bin)

The binary data format stores waveform data in binary format and provides data headers that describe that data.

Because the data is in binary format, the size of the file is approximately 5 times smaller than the XYPairs format.

If more than one source is on, you will save all displayed sources, except math functions, to a file.

When the oscilloscope is in the Peak Detect acquisition mode, the minimum and maximum value waveform data points are saved to the file in separate waveform buffers. The minimum value data points are saved first; then, the maximum value data points are saved.

Binary Data in MATLAB

Binary data from the 6000 Series oscilloscope can be imported to The MathWorks MATLAB®. You can download the appropriate MATLAB functions from the Agilent Technologies web site at www.agilent.com/find/mso6000sw.

Agilent provides the .m files, which need to be copied into the work directory for MATLAB. The default work directory is C:\MATLAB7\work.

Binary Header Format

File Header

There is only one file header in a binary file. The file header consists of the following information.

Cookie Two byte characters, AG, that indicate the file is in the Agilent Binary Data file format.

Version Two bytes that represent the file version.

File Size A 32-bit integer that is the number of bytes that are in the file.

Number of Waveforms A 32-bit integer that is the number of waveforms that are stored in the file.

Waveform Header

It is possible to store more than one waveform in the file, and each waveform stored will have a waveform header. The waveform header contains information about the type of waveform data that is stored following the waveform data header.

Header Size A 32-bit integer that is the number of bytes in the header.

Waveform Type A 32-bit integer that is the type of waveform stored in the file:

- 0 = Unknown.
- 1 = Normal.
- 2 = Peak Detect.
- 3 = Average.
- 4 = Not used in 6000 Series oscilloscopes.
- 5 = Not used in 6000 Series oscilloscopes.
- 6 = Logic.

Number of Waveform Buffers A 32-bit integer that is the number of waveform buffers required to read the data.

Points A 32-bit integer that is the number of waveform points in the data.

Count A 32-bit integer that is the number of hits at each time bucket in the waveform record when the waveform was created using an acquisition mode like averaging. For example, when averaging, a count of four would mean every waveform data point in the waveform record has been averaged at least four times. The default value is 0.

X Display Range A 32-bit float that is the X-axis duration of the waveform that is displayed. For time domain waveforms, it is the duration of time across the display. If the value is zero then no data has been acquired.

X Display Origin A 64-bit double that is the X-axis value at the left edge of the display. For time domain waveforms, it is the time at the start of the display. This value is treated as a double precision 64-bit floating point number. If the value is zero then no data has been acquired.

X Increment A 64-bit double that is the duration between data points on the X axis. For time domain waveforms, this is the time between points. If the value is zero then no data has been acquired.

X Origin A 64-bit double that is the X-axis value of the first data point in the data record. For time domain waveforms, it is the time of the first point. This value is treated as a double precision 64-bit floating point number. If the value is zero then no data has been acquired.

X Units A 32-bit integer that identifies the unit of measure for X values in the acquired data:

- 0 = Unknown.
- 1 = Volts.
- 2 = Seconds.
- 3 = Constant.
- 4 = Amps.
- 5 = dB.
- 6 = Hz.

Y Units A 32-bit integer that identifies the unit of measure for Y values in the acquired data. The possible values are listed above under “X Units”.

Date A16-bit character array, left blank in the 6000 Series oscilloscope.

Time A 16-bit character array, left blank in the 6000 Series oscilloscope.

Frame A 24 byte character array that is the model number and serial number of the oscilloscope in the format of: MODEL#:SERIAL#.

Waveform Label A 16 byte character array that contains the label assigned to the waveform.

Time Tags A 64-bit double, not used in the 6000 Series oscilloscope.

Segment Index A 32-bit unsigned integer, not used in the 6000 Series oscilloscope.

Waveform Data Header

A waveform may have more than one data set. Each waveform data set will have a waveform data header. The waveform data header consists of information about the waveform data set. This header is stored immediately before the data set.

Waveform Data Header Size A 32-bit integer that is the size of the waveform data header.

Buffer Type A 16-bit short that is the type of waveform data stored in the file:

- 0 = Unknown data.
- 1 = Normal 32-bit float data.
- 2 = Maximum float data.
- 3 = Minimum float data.
- 4 = Not used in 6000 Series oscilloscopes.
- 5 = Not used in 6000 Series oscilloscopes.
- 6 = Digital unsigned 8-bit char data (for digital channels).

Bytes Per Point A 16-bit short that is the number of bytes per data point.

Buffer Size A 32-bit integer that is the size of the buffer required to hold the data points.

Example Program for Reading Binary Data

To find an example program for reading binary data, point your web browser to www.agilent.com/find/mso6000, select Library, and click “Example Program for Reading Binary Data”.

Examples of Binary Files

Single Acquisition Multiple Analog Channels

The following picture shows a binary file of a single acquisition with multiple analog channels.

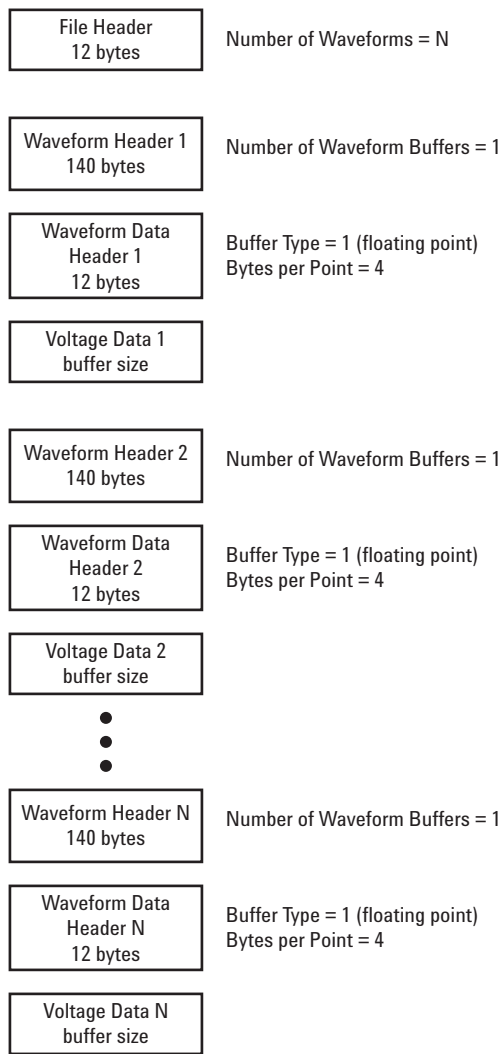

Single Acquisition All Pods Logic Channels

The following picture shows a binary file of a single acquisition with all pods for the logic channels saved.

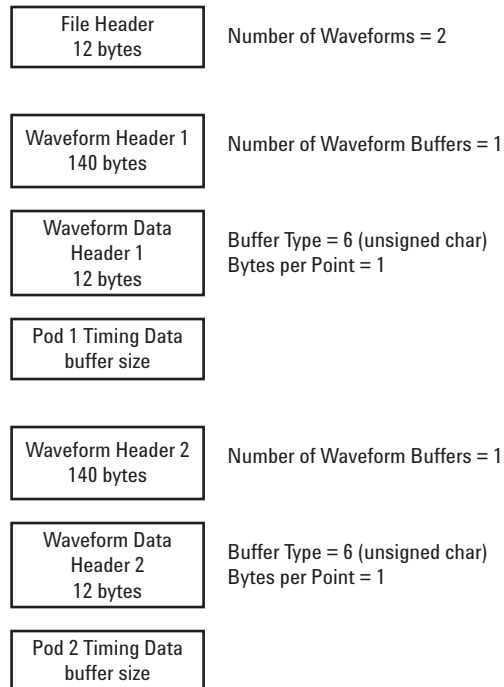



9 Characteristics and Specifications

Specifications	286
Characteristics	287
Environmental Conditions	297
Measurement Category	298

This chapter lists specifications, characteristics, environmental conditions, and measurement category for the Agilent 6000 Series oscilloscopes.



Specifications

All specifications are warranted. Specifications are valid after a 30-minute warm-up period and within $\pm 10^{\circ}\text{C}$ of last “User Cal” temperature.

Table 14 Warranted specifications

Vertical system: oscilloscope channels

Bandwidth (–3dB)	MSO/DSO601xA: DC to 100 MHz MSO/DSO603xA: DC to 300 MHz MSO/DSO605xA: DC to 500 MHz MSO/DSO610xA: DC to 1 GHz
DC vertical gain accuracy	$\pm 2.0\%$ full scale
Dual cursor accuracy ¹	$\pm\{\text{DC vertical gain accuracy} + 0.4\% \text{ full scale } (\sim 1 \text{ LSB})\}$ <i>Example:</i> for 50 mV signal, oscilloscope set to 10 mV/div (80 mV full scale), 5 mV offset, accuracy = $\pm\{2.0\% (80 \text{ mV}) + 0.4\% (80 \text{ mV})\} = \pm 1.92 \text{ mV}$

Vertical system: logic channels (MSO6000A or MSO-upgraded DSO6000A only)

Threshold accuracy	$\pm(100 \text{ mV} + 3\% \text{ of threshold setting})$
--------------------	--

Scope channel triggering

Sensitivity	$< 10 \text{ mV/div}$: greater of 1 div or 5mV; $\geq 10 \text{ mV/div}$: 0.6 div
-------------	---

Logic (D15 - D0) channel triggering (MSO6000A or MSO-upgraded DSO6000A only)

Threshold accuracy	$\pm(100 \text{ mV} + 3\% \text{ of threshold setting})$
--------------------	--

¹ 1 mV/div is a magnification of 2 mV/div setting for 100 MHz models and 2 mV/div is a magnification of 4 mV/div setting for 300 MHz - 1 GHz models. For vertical accuracy calculations, use full scale of 16 mV for 1 mV/div sensitivity setting and 32 mV for 2 mV/div sensitivity setting.

Characteristics

All characteristics are the typical performance values and are not warranted. Characteristics are valid after a 30-minute warm-up period and within $\pm 10^{\circ}\text{C}$ of last “User Cal” temperature.

Table 15 Characteristics

Acquisition: oscilloscope channels

Sample rate	MSO/DSO601xA/603xA: 2 GSa/sec each channel MSO/DSO605xA/610xA: 4 GSa/sec half channel*, 2 GSa/sec each channel
Standard memory depth	With logic channels turned off, 1 Mpts half channel*, 500 kpts each channel With logic channels turned on, 625 kpts half channel*, 312 kpts each channel
Optional memory depth	With logic channels turned off, Option 2ML or 2MH – 2 Mpts half channel*, 1 Mpts each channel Option 8ML or 8MH – 8 Mpts half channel*, 4 Mpts each channel With logic channels turned on, Option 2ML or 2MH – 1.25 Mpts half channel*, 625 kpts each channel Option 8ML or 8MH – 5 Mpts half channel*, 2.5 Mpts each channel
Vertical resolution	8 bits
Peak detection	MSO/DSO601xA: 1-ns peak detect MSO/DSO603xA: 500-ps peak detect MSO/DSO605xA/610xA: 250-ps peak detect
Averaging	Selectable from 2, 4, 8, 16, 32, 64 ... to 65536
High resolution mode	Average mode with #avg = 1 12 bits of resolution when $\geq 10 \mu\text{s}/\text{div}$, at 4 GSa/s or $\geq 20 \mu\text{s}/\text{div}$, at 2 GSa/s
Filter	Sin x/x interpolation (single shot BW = sample rate/4 or bandwidth of oscilloscope, whichever is less) with vectors on and in real-time mode

* Half channel is when only one of channel pair 1 or 2 is turned on, or only channel pair 3 or 4 is turned on.

9 Characteristics and Specifications

Acquisition: logic channels (MSO6000A or MSO-upgraded DSO6000A only)

Sample rate	2 GSa/sec one pod, 1 GSa/sec each pod
Maximum input frequency	250 MHz
Standard memory depth	With oscilloscope channels turned off, 1 Mpts one pod, 500 kpts each pod With oscilloscope channels turned on, 312 kpts one pod, 156 kpts each pod
Optional memory depth	With oscilloscope channels turned off, Option 2ML or 2MH – 2 Mpts one pod, 1 Mpts each pod Option 8ML or 8MH – 8 Mpts one pod, 4 Mpts each pod With oscilloscope channels turned on, Option 2ML or 2MH – 625 kpts one pod, 312 kpts each pod Option 8ML or 8MH – 2.5 Mpts one pod, 1.25 Mpts each pod
Vertical resolution	1 bit
Glitch detection	2 ns (min pulse width)

Vertical system: oscilloscope channels

Scope channels	MSO/DSO6xx2A: Ch 1 and 2 simultaneous acquisition MSO/DSO6xx4A: Ch 1, 2, 3 and 4 simultaneous acquisition
AC coupled	MSO/DSO601xA: 3.5 Hz to 100 MHz MSO/DSO603xA: 3.5 Hz to 300 MHz MSO/DSO605xA: 3.5 Hz to 500 MHz MSO/DSO610xA: 3.5 Hz to 1 GHz
Calculated rise time (= 0.35/bandwidth)	MSO/DSO601xA: 3.5 nsec MSO/DSO603xA: 1.17 nsec MSO/DSO605xA: 700 psec MSO/DSO610xA: 350 psec
Single-shot bandwidth	MSO/DSO601xA: 100 MHz MSO/DSO603xA: 300 MHz MSO/DSO605xA: 500 MHz MSO/DSO610xA: 1 GHz (in half-channel mode, i.e., one channel of channel pair is on)
Range ¹	MSO/DSO601xA: 1 mV/div to 5 V/div (1 M Ω) MSO/DSO603xA and MSO/DSO605xA: 2 mV/div to 5 V/div (1 M Ω or 50 Ω) MSO/DSO610xA: 2 mV/div to 5 V/div (1 M Ω), 2 mV/div to 1 V/div (50 Ω)
Maximum input	 CAT I 300 Vrms, 400 Vpk; transient overvoltage 1.6 kVpk CAT II 100 Vrms, 400 Vpk With 10073C 10:1 probe: CAT I 500 Vpk, CAT II 400 Vpk
Offset range	± 5 V on ranges <10 mV/div; ± 20 V on ranges 10 mV/div to 200 mV/div; ± 75 V on ranges >200 mV/div

¹ 1 mV/div is a magnification of 2 mV/div setting for 100 MHz models and 2 mV/div is a magnification of 4 mV/div setting for 300 MHz - 1 GHz models. For vertical accuracy calculations, use full scale of 16 mV for 1 mV/div sensitivity setting and 32 mV for 2 mV/div sensitivity setting.

Vertical system: oscilloscope channels (continued)

Dynamic range	±8 div
Input impedance	MSO/DSO601xA: 1 MΩ ± 1% 11 pF MSO/DSO603xA/605xA/610xA: 1 MΩ ± 1% 14 pF or 50 Ω ± 1.5%, selectable
Coupling	AC, DC
BW limit	25 MHz selectable, on the 300 MHz, 500 MHz, and 1 GHz bandwidth models 20 MHz selectable, on the 100 MHz bandwidth models
Channel-to-channel isolation	DC to max bandwidth >40 dB
Standard probes	MSO/DSO601xA: 10:1 10074C shipped standard for each oscilloscope channel MSO/DSO603xA/605xA/610xA: 10:1 10073C shipped standard for each oscilloscope channel
Probe ID	MSO/DSO601xA: Auto probe sense MSO/DSO603xA/605xA/610xA: Auto probe sense and AutoProbe interface Agilent- and Tektronix-compatible passive probe sense
ESD tolerance	±2 kV
Noise peak-to-peak	MSO/DSO601xA: 3% full scale or 2 mV, whichever is greater MSO/DSO603xA: 3% full scale or 3 mV, whichever is greater MSO/DSO605xA: 3% full scale or 3.6 mV, whichever is greater MSO/DSO610xA: 3% full scale or 4 mV, whichever is greater
DC vertical offset accuracy	≤ 200 mV/div: ±0.1 div ±2.0 mV ±0.5% offset value; >200 mV/div: ±0.1 div ±2.0 mV ±1.5% offset value
Single cursor accuracy ¹	±{DC vertical gain accuracy + DC vertical offset accuracy + 0.2% full scale (~1/2 LSB)} <i>Example:</i> for 50 mV signal, oscilloscope set to 10 mV/div (80 mV full scale), 5 mV offset, accuracy = ±{2.0% (80 mV) + 0.1 (10 mV) + 2.0 mV + 0.5% (5 mV) + 0.2%(80 mV)} = ± 4.785 mV

Vertical system: logic channels (MSO6000A or MSO-upgraded DSO6000A only)

Number of channels	16 logic timing channels – labeled D15 - D0
Threshold groupings	Pod 1: D7 - D0 Pod 2: D15 - D8
Threshold selections	TTL, CMOS, ECL and user-definable (selectable by pod)
User-defined threshold range	±8.0 V in 10 mV increments
Maximum input voltage	±40 V peak CAT I; transient overvoltage 800 Vpk
Input dynamic range	±10 V about threshold
Minimum input voltage swing	500 mV peak-to-peak
Input capacitance	~8 pF
Input resistance	100 kΩ ±2% at probe tip
Channel-to-channel skew	2 ns typical, 3 ns maximum

¹ 1 mV/div is a magnification of 2 mV/div setting for 100 MHz models and 2 mV/div is a magnification of 4 mV/div setting for 300 MHz - 1 GHz models. For vertical accuracy calculations, use full scale of 16 mV for 1 mV/div sensitivity setting and 32 mV for 2 mV/div sensitivity setting.

9 Characteristics and Specifications

Horizontal

Range	MSO/DSO601xA: 5 nsec/div to 50 sec/div MSO/DSO603xA: 2 nsec/div to 50 sec/div MSO/DSO605xA: 1 nsec/div to 50 sec/div MSO/DSO610xA: 500 psec/div to 50 sec/div
Resolution	2.5 psec
Timebase accuracy	15 ppm ($\pm 0.0015\%$)
Vernier	1-2-5 increments when off, ~ 25 minor increments between major settings when on
Delay range	Pre-trigger (negative delay): Greater of 1 screen width or 1 ms (with 8 Mpts memory option) Greater of 1 screen width or 250 μ s (with 2 Mpts memory option) Greater of 1 screen width or 125 μ s (with standard memory) Post-trigger (positive delay): 1 s - 500 seconds
Analog delta-t accuracy	Same channel: $\pm 0.0015\%$ reading $\pm 0.1\%$ screen width ± 20 ps Channel-to-channel: $\pm 0.0015\%$ reading $\pm 0.1\%$ screen width ± 40 ps <i>Same channel example (MSO/DSO605xA):</i> For signal with pulse width of 10 μ s, oscilloscope set to 5 μ s/div (50 μ s screen width), delta-t accuracy = $\pm\{0.0015\% (10 \mu\text{s}) + 0.1\% (50 \mu\text{s}) + 20 \text{ps}\} = 50.17 \text{ ns}$
Logic delta-t accuracy	Same channel: $\pm 0.005\%$ reading $\pm 0.1\%$ screen width $\pm(1$ logic sample period, 1 ns) Channel-to-channel: $\pm 0.005\%$ reading $\pm 0.1\%$ screen width $\pm(1$ logic sample period) \pm chan-to-chan skew <i>Same channel example:</i> For signal with pulse width of 10 μ s, oscilloscope set to 5 μ s/div (50 μ s screen width), delta-t accuracy = $\pm\{0.005\% (10 \mu\text{s}) + 0.1\% (50 \mu\text{s}) + 1 \text{ns}\} = 51.5 \text{ ns}$
Modes	Main, delayed, roll, XY
XY	Bandwidth: Max bandwidth Phase error @ 1 MHz: < 0.5 degrees Z Blanking: 1.4 V blanks trace (use external trigger on MSO/DSO6xx2A, channel 4 on MSO/DSO6xx4A)
Reference positions	Left, center, right

Trigger system

Sources	MSO6xx2A: Ch 1, 2, line, ext, D15 - D0 DSO6xx2A h 1, 2, line, ext MSO6xx4A: Ch 1, 2, 3, 4, line, ext, D15 - D0 DSO6xx4A: Ch 1, 2, 3, 4, line, ext
Modes	Auto, Normal (triggered), single
Holdoff time	~ 60 ns to 10 seconds
Trigger jitter	15 ps rms

Trigger system (continued)

Selections	Edge, pulse width, pattern, TV, duration, sequence, CAN, LIN, USB, I ² C, SPI, Nth edge burst.
Edge	Trigger on a rising, falling, alternating or either edge of any source
Pattern	Trigger at the beginning of a pattern of high, low, and don't care levels and/or a rising or falling edge established across any of the analog and digital channels, but only after a pattern has been established for a minimum of 2 nsec. The oscilloscope channel's high or low level is defined by that channel's trigger level. The logic channel's trigger level is defined by the threshold for the pod, 0 - 7 or 8 - 15.
Pulse width	Trigger when a positive- or negative-going pulse is less than, greater than, or within a specified range on any of the source channels. Minimum pulse width setting: 5 ns (MSO/DSO601xA/603xA oscilloscope channels) 2 ns (MSO/DSO605xA/610xA oscilloscope channels) 2 ns (logic channels on MSO6000A or MSO-upgraded DSO6000A) Maximum pulse width setting: 10 s
TV	Trigger using any oscilloscope channel on most analog progressive and interlaced video standards including HDTV/EDTV, NTSC, PAL, PAL-M or SECAM broadcast standards. Select either positive or negative sync pulse polarity. Modes supported include Field 1, Field 2, all fields, all lines, or any line within a field. TV trigger sensitivity: 0.5 division of sync signal. Trigger holdoff time can be adjusted in half field increments.
Sequence	Arm on event A, trigger on event B, with option to reset on event C or time delay.
CAN	Trigger on CAN (Controller Area Network) version 2.0A and 2.0B signals. Trigger on the start of frame (SOF) bit (standard). N5424A option supports triggering on remote frame ID (RTR), data frame ID (~RTR), remote or data frame ID, data frame ID and data, error frame, all errors, acknowledge error and overload frame.
LIN	Trigger on LIN (Local Interconnect Network) sync break at beginning of message frame (standard). N5424A option supports triggering on frame ID.
USB	Trigger on USB (Universal Serial Bus) start of packet, end of packet, reset complete, enter suspend, or exit suspend on the differential USB data lines. USB low speed and full speed are supported.
I ² C	Trigger on I ² C (Inter-IC bus) serial protocol at a start/stop condition or user defined frame with address and/or data values. Also trigger on missing acknowledge, restart, EEPROM read, and 10-bit write.
SPI	Trigger on SPI (Serial Protocol Interface) data pattern during a specific framing period. Supports positive and negative Chip Select framing as well as clock Idle framing and user-specified number of bits per frame.

9 Characteristics and Specifications

Duration	Trigger on a multi-channel pattern whose time duration is less than a value, greater than a value, greater than a time value with a timeout, or inside or outside of a set of time values. Minimum duration setting: 2 ns Maximum duration setting: 10 s
Nth Edge Burst	Trigger on the Nth edge of a burst that occurs after an idle time.

Trigger system (continued)

Autoscale	Finds and displays all active oscilloscope and logic (for MSO6000A series MSO) channels, sets edge trigger mode on highest-numbered channel, sets vertical sensitivity on oscilloscope channels and thresholds on logic channels, time base to display ~1.8 periods. Requires minimum voltage >10 mVpp, 0.5% duty cycle and minimum frequency >50 Hz.
-----------	---

Oscilloscope channel triggering

Range (internal)	±6 div from center screen
Coupling	AC (~3.5 Hz on MSO/DSO601xA, ~10 Hz on MSO/DSO603xA/605xA/610xA), DC, noise reject, HF reject and LF reject (~50 kHz)

Logic (D15 - D0) channel triggering (MSO6000A or MSO-upgraded DSO6000A only)

Threshold range (user defined)	±8.0 V in 10 mV increments
Predefined thresholds	TTL = 1.4 V, CMOS = 2.5 V, ECL = -1.3 V

	MSO/DSO6xx2A (2-/2+16-ch models)	MSO/DSO6xx4A (4-/4+16-ch models)
External (EXT) triggering		
Input impedance	MSO/DSO6012A: 1 MΩ ±3% 11 pF or 50 Ω MSO/DSO6032A/6052A/6102A: 1 MΩ ±3% 14 pF or 50 Ω	MSO/DSO6014A: 1.015 kΩ ±5% MSO/DSO6034A/6054A/ 6104A: 2.14 kΩ ±5%
Maximum input	 CAT I 300 Vrms, 400 Vpk, CAT II 100 Vrms, 400 Vpk With 10073C 10:1 probe: CAT I 500 Vpk, CAT II 400 Vpk 5 Vrms with 50-ohm input	±15 V
Range	DC coupling: trigger level ± 1V and ± 8V	±5 V

Sensitivity	For $\pm 1V$ range setting: DC to 100 MHz, 100 mV; MSO/DSO6032A/6052A/6102A >100 MHz to bandwidth of oscilloscope: 200 mV	MSO/DSO6014A: DC to 100 MHz: 500 mV
	For $\pm 8V$ range setting: DC to 100 MHz, 250 mV; MSO/DSO6032A/6052A/6102A >100 MHz to bandwidth of oscilloscope: 500 mV	MSO/DSO6034A/6054A/ 6104A: DC to 500 MHz: 500 mV
Coupling	AC (~3.5 Hz), DC, noise reject, HF reject and LF reject (~50 kHz)	
Probe ID	MSO/DSO601xA: Auto probe sense MSO/DSO603xA/605xA/610xA: Auto probe sense and AutoProbe interface Agilent- and Tektronix-compatible passive probe sense	
Display system		
Display	6.3-inch (161 mm) diagonal color TFT LCD	
Throughput of oscilloscope channels	Up to 100,000 waveforms/sec in real-time mode	
Resolution	XGA – 768 vertical by 1024 horizontal points (screen area); 640 vertical by 1000 horizontal points (waveform area) 256 levels of intensity scale	
Controls	Waveform intensity on front panel. Vectors on/off; infinite persistence on/off, 8 x 10 grid with intensity control	
Built-in help system	Key-specific help (in English) displayed by pressing and holding key or softkey of interest	
Real-time clock	Time and date (user adjustable)	
Measurement features		
Automatic measurements	Measurements are continuously updated. Cursors track last selected measurement.	
Voltage (scope channels only)	Peak-to-peak, maximum, minimum, average, amplitude, top, base, overshoot, preshoot, RMS, standard deviation	
Time	Frequency, period, + width, – width and duty cycle on any channel. Rise time, fall time, X at max Y (time at max volts), X at min Y (time at min volts), delay, and phase on oscilloscope channels only.	
Counter	Built-in 5-digit frequency counter on any channel. Counts up to the oscilloscope's bandwidth (1 GHz max). The counter resolution can be increased to 8 digits with an external 10 MHz reference.	
Threshold definition	Variable by percent and absolute value; 10%, 50%, 90% default for time measurements	

9 Characteristics and Specifications

Cursors	Manually or automatically placed readout of Horizontal (X, ΔX , $1/\Delta X$) and Vertical (Y, ΔY). Additionally logic or oscilloscope channels can be displayed as binary or hex values.
Waveform math	One function of 1-2, 1x2, FFT, differentiate, integrate. Source of FFT, differentiate, integrate: oscilloscope channels 1 or 2, 1-2, 1+2, 1x2.

FFT

Points	Fixed at 1000 points
Source of FFT	Scope channels 1 or 2 (or 3 or 4 on MSO/DSO6xx4A only), 1+2, 1-2, 1*2
Window	Rectangular, flattop, hanning
Noise floor	-50 to -90 dB depending on averaging
Amplitude	Display in dBV, dBm at 50 Ω
Frequency resolution	0.05/time per div
Maximum frequency	50/time per div

Storage

Save/recall	10 setups and traces can be saved and recalled using internal non-volatile memory
Storage type and format	USB 1.1 host ports on front and rear panels Image formats: BMP (8-bit), BMP (24-bit), PNG (24-bit) Data formats: X and Y (time/voltage) values in CSV format, ASCII XY format, BIN format Trace/setup formats: Recalled

I/O

Standard ports	USB 2.0 high speed device, two USB 1.1 host ports, 10/100-BaseT LAN, IEEE488.2 GPIB, XGA video output
Max transfer rate	IEEE488.2 GPIB: 500 kbytes/sec USB (USBTMC-USB488): 3.5 Mbytes/sec 100 Mbps LAN (TCP/IP): 1 Mbytes/sec
Printer compatibility	Selected HP Deskjet, Officejet, and HP PCL 3.0 compatible printers

General characteristics

Physical size	35.4 cm wide x 18.8 cm high x 28.2 cm deep (without handle) 39.9 cm wide x 18.8 cm high x 28.2 cm deep (with handle)
Weight	Net: 4.9 kgs (10.8 lbs) Shipping: 9.4 kgs (20.7 lbs)
Probe comp output	Frequency ~1.2 kHz, Amplitude ~2.5 V

Trigger out	When "Triggers" is selected (delay ~17 ns) 0 to 5 V into open circuit 0 to 2.5 V into 50 Ω When "Source Frequency" or "Source Frequency/8" is selected 0 to 580 mV into open circuit 0 to 290 mV into 50 Ω Max frequency output: 350 MHz (in Source Frequency mode when terminated in 50 Ω) 125 MHz (in Source Frequency/8 mode when terminated in 50 Ω)
10 MHz ref in/out	TTL out, 180 mV to 1 V amplitude with 0 to 2 V offset
Kensington lock	Connection on rear panel for security

Power requirements

Line voltage range	~Line 120 W max, 96-144 V/48-440 Hz, 192-288 V/48-66 Hz, automatic selection
Line frequency	50/60 Hz, 100-240 VAC; 440 Hz, 100-132 VAC
Power usage	110 W max

Environmental characteristics

Ambient temperature	Operating -10 °C to +55 °C; non-operating -51 °C to +71 °C
Humidity	Operating 95% RH at 40 °C for 24 hr; non-operating 90% RH at 65 °C for 24 hr
Altitude	Operating to 4,570 m (15,000 ft); non-operating to 15,244 m (50,000 ft)
Vibration	Agilent class B1 and MIL-PRF-28800F; Class 3 random
Shock	Agilent class B1 and MIL-PRF-28800F; (operating 30 g, 1/2 sine, 11-ms duration, 3 shocks/axis along major axis. Total of 18 shocks)
Pollution degree2	Normally only dry non-conductive pollution occurs. Occasionally a temporary conductivity caused by condensation must be expected.
Indoor use	Rated for indoor use only

Other

Measurement categories	CAT I: Mains isolated CAT II: Line voltage in appliance and to wall outlet
Regulatory information	Safety IEC 61010-1:2001 / EN 61010-1:2001 Canada: CSA C22.2 No. 1010.1:1992 UL 61010B-1:2003
Supplementary information	The product herewith complies with the requirements of the Low Voltage Directive 73/23/EEC and the EMC Directive 89/336/EEC, and carries the CE-marking accordingly. The product was tested in a typical configuration with HP/Agilent test systems.

Product specifications, characteristics, and descriptions in this document are subject to change without notice.

WARNING

Use this instrument only for measurements within its specified measurement categories.

Environmental Conditions

Overvoltage Category

This product is intended to be powered by MAINS that comply to Overvoltage Category II, which is typical of cord-and-plug connected equipment.

Pollution Degree

The 6000 Series Oscilloscope may be operated in environments of Pollution Degree 2 (or Pollution Degree 1).

Pollution Degree Definitions

Pollution Degree 1: No pollution or only dry, non-conductive pollution occurs. The pollution has no influence. Example: A clean room or climate controlled office environment.

Pollution Degree 2. Normally only dry non-conductive pollution occurs. Occasionally a temporary conductivity caused by condensation may occur. Example: General indoor environment.

Pollution Degree 3: Conductive pollution occurs, or dry, non-conductive pollution occurs which becomes conductive due to condensation which is expected. Example: Sheltered outdoor environment.

Measurement Category

Measurement Category

The 6000 Series oscilloscope is intended to be used for measurements in Measurement Category I.

Measurement Category Definitions

Measurement category I is for measurements performed on circuits not directly connected to MAINS. Examples are measurements on circuits not derived from MAINS, and specially protected (internal) MAINS derived circuits. In the latter case, transient stresses are variable; for that reason, the transient withstand capability of the equipment is made known to the user.

Measurement category II is for measurements performed on circuits directly connected to the low voltage installation. Examples are measurements on household appliances, portable tools and similar equipment.

Measurement category III is for measurements performed in the building installation. Examples are measurements on distribution boards, circuit-breakers, wiring, including cables, bus-bars, junction boxes, switches, socket-outlets in the fixed installation, and equipment for industrial use and some other equipment, for example, stationary motors with permanent connection to the fixed installation.

Measurement category IV is for measurements performed at the source of the low-voltage installation. Examples are electricity meters and measurements on primary overcurrent protection devices and ripple control units.

Transient Withstand Capability

CAUTION

Maximum input voltage for analog inputs:

CAT I 300 Vrms, 400 Vpk; transient overvoltage 1.6 kVpk

CAT II 100 Vrms, 400 Vpk

with 10073C or 10074C 10:1 probe: CAT I 500 Vpk, CAT II 400 Vpk

CAUTION

Do not exceed 5 Vrms in 50 Ω mode on the 2-channel models. Input protection is enabled in 50 Ω mode, and the 50 Ω load will disconnect if greater than 5 Vrms is detected. However, the input could still be damaged, depending on the time constant of the signal.

CAUTION

The 50 Ω input protection mode only functions when the oscilloscope is powered on.

CAUTION

Maximum input voltage for logic channels:

± 40 V peak CAT I; transient overvoltage 800 Vpk

Index

Symbols

- (-)Width measurement, 189
- (+)Width measurement, 189

Numerics

- 1*2 math function, 161
- 1-2 math function, 163

A

- about oscilloscope, 72
- AC channel coupling, 50
- accessories, 16, 18
- acquire, 211
- acquisition memory, 90
- acquisition mode, 209
 - averaging, 211
 - high resolution, 210
 - normal, 209
 - peak detect, 210
- acquisition option
 - realtime, 213
- active probes, 26
- active serial bus, 219, 223, 228, 237
- activity indicator, 82
- adding digital channels license, 264
- addition, 163
- address with no ack condition, I2C trigger, 116
- adjust the handle, 19
- aliasing, FFT, 169
- Amplitude measurement, 194
- analog channel
 - probe attenuation, 52
 - setup, 48
- analog filters, adjusting, 169

- analog probes, 22
- ASCII XY data file format, 247
- attenuation factor, 46
- attenuation, probe, 52, 97
- Auto trigger indicator, 37, 91
- auto trigger mode, 45, 91
- automatic measurements, 61, 182
- automatic setup, 45, 80
- AutoProbe, 36, 50
 - external trigger, 97
- Autosave traces and setups, 256
- Autoscale, 45
 - digital channels, 80
- autoscale key, 38
- auto-single, 44
- Average measurement, 195
- averaging acquire mode, 211

B

- bandwidth limit, 51
- bandwidth, oscilloscope, 213
- Base measurement, 195
- BIN data file format, 247
- binary cursors, 177
- binary data (.bin), 277
- binary data file examples, 282
- binary data in MATLAB, 277
- binary data, example program for reading, 281
- bitmap image file, 246
- bits, SPI trigger, 137
- blanking, 59, 157
- BMP (24-bit) image file format, 246
- BMP (8-bit) image file format, 246
- brightness of waveforms, 35

C

- calibrate probe, 52
- CAN decode
 - source channels, 227
- CAN frame counter, 230
- CAN serial decode, 225
- CAN Signals Menu, 226
- CAN totalizer, 230
- CAN trigger, 107
- Center, FFT, 172
- channel
 - analog, 48
 - bandwidth limit, 51
 - coupling, 50
 - invert, 51
 - on/off keys, 36
 - position, 49
 - probe units, 52
 - skew, 52
 - vernier, 49
 - vertical sensitivity, 49
- channel pair, 213, 287, 288
- characteristics, 287
- choosing values, 32
- cleaning, 270
- clear display, 205, 241
- clock, 66
- CMOS threshold, 85
- comma separated value data file
 - format, 246
- comparison of measurement results, 255
- compensate probes, 35
- compensating your probe, 24
- configure printer, 246

Index

connect probes
 analog, 22
 digital, 76
connect the dots, 206
control oscilloscope, 265
controls, front panel, 34, 39
conventions, 32, 33
Counter measurement, 187
counter, CAN frame, 230
coupling, channel, 50
crosstalk problems, 169
CSV data file format, 246
cursor measurements, 60, 176
cursors, measure, 260

D

D*, 84
d/dt math function, 165
damage, shipping, 16
DC channel coupling, 50
default configuration, 73
default label library, 65
default setup, 73
delay knob, 55
Delay measurement, 191
delay time indicator, 54
delayed mode, 55
delayed sweep, 55, 180, 188, 198
delete file, 261, 262
differentiate math function, 165
digital channel controls, 35
digital channel menu, 83
digital channels, 5, 16, 41, 83
 Autoscale, 80
 display, 46
 enabling, 264
 logic threshold, 85
 probing, 271
 size, 84
digital display, interpreting, 82
digital probes, 76, 271
 impedance, 271
digital select key, 32

display, 38, 39
 area, 40
 clear, 205
 intensity, 41
 interpreting, 39
 measurement line, 40
 modes, 205
 signal detail, 207
 softkeys, 40
 status line, 40
 vectors, 206
display multiple acquisitions, 42
distortion problems, 169
download Quick Help language file, 29
drive0, 250, 256, 261
drive5, 250, 256, 261
DSO, 4
duration trigger, 111
Duty cycle measurement, 187

E

ECL threshold, 85
edge triggering, 100
EEPROM data read, I2C trigger, 117
energy of a pulse, 167
Entry knob, 32, 33, 38
environmental conditions, 297
expand about, 49, 68, 203
expand about center, 68
expand about ground, 68
external memory device, 35
external trigger
 input impedance, 97, 98
 probe attenuation, 97
 probe settings, 96
 probe units, 98
eye diagrams, 213

F

factory default configuration, 73
Fall time measurement, 189
FFT measurements, 169
FFT window, 173

file explorer, 261
file formats, print, 246
file keys, 36
firmware updates, 264
firmware version information, 266
Flat top window, 173
frame trigger, I2C, 117, 118
Frequency measurement, 188
front-panel, 34, 39
 overview, 31

G

glitch trigger, 102
GPIB control, 265
grabber, 77, 78
graphic conventions, 33
graticule, 41
grid intensity, 41
ground level, 49

H

half channel, 287, 288
handle, 19
Hanning window, 173
HDTV trigger, 137
hex cursors, 177
HF Reject, 93, 238, 239
high-frequency noise rejection, 238, 239
high-resolution mode, 210
holdoff, 94
horizontal delay control, 37
horizontal main/delayed key, 38
Horizontal section, 53
horizontal time/div control, 38
horizontal vernier, 54
host name, 266
hysteresis, trigger, 239

I

I/O port configuration, 265
I2C serial decode, 216

- I2C Signals Menu, 217
 - I2C trigger, 114
 - idle serial bus, 219, 223, 228, 237
 - Imped softkey, 50
 - impedance
 - digital probes, 271
 - external trigger, 98
 - indeterminate state, 177
 - infinite persistence, 42, 205, 240
 - infrequent triggers, 213
 - input impedance
 - channel input, 50
 - external trigger, 98
 - input voltage, 23, 97
 - instantaneous slope of a waveform, 165
 - Integrate math function, 167
 - intensity control, 35, 41
 - invert, 51
 - IP address, 266
- L**
- label key, 36
 - label list, 65
 - labels, 61
 - default library, 65
 - LAN control, 265
 - length softkey, 247
 - LF Reject, 239
 - library, labels, 63
 - licenses, 73, 264
 - LIN serial decode, 232
 - LIN Signals Menu, 233
 - LIN trigger, 122
 - load file, 261, 262
 - load traces and setups, 255, 260
 - logic threshold, 85
 - low-frequency noise rejection, 239
- M**
- main horizontal mode, 53
- math**
- 1*2, 161
 - 1-2, 163
 - differentiate, 165
 - FFT, 169
 - functions, 159
 - integrate, 167
 - measurements, 194
 - multiply, 161
 - offset, 160
 - scale, 160
 - subtract, 163
 - units, 160
- math key, 36
- MATLAB binary data, 277
 - Maximum measurement, 195
 - maximum sample rate, 213
 - measure keys, 38
 - measure, recalled trace, 260
 - measurement category, 298
 - definitions, 298
 - measurement definitions, 187
 - measurement line, 40
 - measurement thresholds, 184
 - measurements, 61, 245
 - MegaZoom III, 4
 - memory depth, 43
 - upgrade, 264
 - Minimum measurement, 195
 - missing acknowledge condition, I2C trigger, 116
 - Mode/Coupling key, trigger, 90
 - model number, 266
 - MSO, 4
 - MSO feature upgrade, 264
 - Multiply math function, 161
- N**
- network configuration parameters, 266
 - network status information, 266
 - new label, 64
- noise**
- high-frequency, 238, 239
 - low-frequency, 239
- noise reject, 93
- normal acquire mode, 209
 - normal cursors, 176
 - Normal trigger mode, 37, 45, 92
 - Nth Edge 2, 129
 - Nth Edge 2 (no re-find), 130
 - Nth edge burst triggering, 120
- O**
- options, print, 249
 - Overshoot measurement, 200
 - overvoltage category, 297
- P**
- pan and zoom, 44, 202
 - parts, replacement, 276
 - passive probes, 25
 - pattern
 - duration trigger, 111
 - pattern trigger, 105
 - SPI trigger, 137
 - pattern trigger, 105
 - peak detect acquire mode, 210, 240
 - Peak-peak measurement, 195
 - Period measurement, 188
 - persistence, infinite, 42
 - Phase measurement, 192
 - PNG (24-bit) image file format, 246
 - pollution degree, 297
 - definitions, 297
 - position, analog, 49
 - post-processing, 153
 - power switch, 20, 35
 - power-on, 20
 - predefined labels, 63
 - Preset, FFT, 172
 - Preshoot measurement, 199

Index

print, [66](#), [250](#)
 file formats, [246](#)
 to file, [250](#)
print options, [249](#)
print screen, [250](#), [251](#)
print the display, [250](#), [251](#)
printers

 configuring, [246](#)
 supported, [252](#)
 USB, [251](#)

probe
 autoprobe interface, [36](#)
 calibrate, [52](#)
probe attenuation, [52](#), [97](#)
probe compensation, [35](#)
probe factor, [46](#)
probe units, [52](#), [98](#)
probes

 active, [26](#)
 analog, [22](#)
 compensating, [24](#)
 digital, [76](#)
 passive, [25](#)

pulse polarity, [103](#)
pulse width trigger, [102](#)

Q

qualifier, [103](#)
Quick Help, [28](#)
Quick Meas, [61](#), [182](#)
Quick Print, [66](#), [250](#)

R

random noise, [238](#)
realtime acquire option, [213](#)
Realtime sampling and bandwidth, [214](#)
recall traces and setups, [255](#), [260](#)
record length, [43](#)
Rectangular window, [173](#)
remote display, web, [265](#)
replacement parts, [276](#)
restart condition, I2C trigger, [116](#)

return instrument for service, [270](#)
Rise time measurement, [189](#)
RMS measurement, [196](#)
roll mode, [58](#)
run controls, [37](#)
Run/Stop key, [42](#)
runt pulses, [189](#)

S

sample rate, [5](#), [210](#), [213](#)
 current rate displayed, [53](#)
save file, [261](#)
save traces and setups, [255](#), [257](#), [258](#)
Save/Recall, [255](#)
saver, screen, [67](#)
SCL, I2C trigger, [115](#)
screen saver, [67](#)
SDA, [114](#)
SDA, I2C trigger, [115](#)
selecting
 digital channels, [32](#)
 values, [32](#)
Self Test, service, [72](#)
sequence trigger, [125](#)
serial clock, I2C trigger, [115](#)
serial data, [114](#)
serial data, I2C trigger, [115](#)
serial decode, [215](#), [247](#)
serial number, [266](#)
service functions, [69](#)
setup, automatic, [45](#), [80](#)
setup, default, [73](#)
shipping damage, [16](#)
shipping precautions, [270](#)
single acquisition, [37](#), [43](#)
Single key, [43](#)
size, [84](#)
skew, analog channel, [52](#)
slope trigger, [100](#)
softkeys, [32](#), [38](#), [40](#)
software updates, [264](#)
source frequency, [151](#)
Span, FFT, [171](#)

specifications, [286](#)
spectral leakage, FFT, [171](#)
SPI serial decode, [220](#)
SPI Signals Menu, [221](#)
SPI trigger, [132](#)
stage, sequence, [127](#)
start acquisition, [37](#), [42](#)
start condition, I2C, [116](#)
status line, [40](#)
status, User Cal, [71](#)
Std Deviation measurement, [196](#)
stop acquisition, [37](#), [42](#)
stop condition, I2C, [116](#)
Subtract math function, [163](#)
sweep speed vernier, [54](#)
symbols, graphic, [33](#)
sync polarity, TV trigger, [139](#)

T

threshold
 analog channel measurements, [184](#)
 digital channels, [85](#)
tilt for viewing, [19](#)
time measurements, [186](#)
time reference, [54](#)
time reference indicator, [54](#)
timebase, [53](#)
Top measurement, [198](#)
totalizer, CAN, [230](#)
transient withstand capability, [299](#)
trigger
 coupling, [93](#)
 external, [96](#)
 HF Reject, [93](#)
 holdoff, [94](#)
 hysteresis, [239](#)
 mode, [90](#)
 mode/coupling, [90](#)
 noise reject, [93](#)
 source, [101](#)
trigger controls, [37](#)

trigger mode
 auto, 45, 91
 normal, 45, 92
 Trigger Out connector, 151
 trigger type, 99
 CAN, 107
 duration, 111
 edge, 100
 glitch, 102
 I2C, 114
 LIN, 122
 Nth edge burst, 120
 pattern, 105
 pulse width, 102
 sequence, 125
 slope, 100
 SPI, 132
 TV, 137
 USB, 149
 triggers, 151
 TTL threshold, 85
 turn channel on, 36
 TV trigger, 137

U

undo Autoscale, 45, 243
 units, math, 160
 units, probe, 52, 98
 unstable triggers, 213
 updating software and firmware, 264
 upgrading the oscilloscope, 264
 upload new firmware, 266
 USB client port, 251
 USB control, 265
 USB mass storage device
 numbering, 250, 256, 261
 USB ports, 35
 USB printer, 251
 USB trigger, 149
 USB, eject device, 35
 user cal, 69
 User-defined threshold, 85
 utility key, 36

V

values, choosing, 32
 vectors, 206
 ventilation requirements, 20
 vernier, channel, 49
 vernier, sweep speed, 54
 vertical expansion, 49
 vertical position, 49
 vertical position control, 35
 vertical sensitivity, 36, 49
 viewing signals, 207
 viewing, tilt the instrument, 19
 VISA connect string, 266
 voltage measurements, 193

W

warranted specifications, 286
 warranty, 269
 waveform keys, 37
 waveform reference point, 68
 web interface, 265
 Width - measurement, 189
 Width + measurement, 189
 Window, FFT, 173

X

X and Y cursors, 177
 X at Max measurement, 190
 X at Max on FFT, 186, 187
 X at Min measurement, 190
 XY mode, 59, 154

Y

Y and X cursors, 177

Z

Z-axis blanking, 59, 157
 zoom and pan, 44, 202

www.agilent.com

© Agilent Technologies, Inc. 2005-2006

Printed in Malaysia
Fourth Edition, June 2006



54684-97011

